

Waters™



DISCOVERY HYBRID RHEOMETERS
TEMPERATURE SYSTEMS AND ACCESSORIES

The World's Most VERSATILE PLATFORM for Rheological Measurements

All DHR temperature systems and accessories are designed with superior performance and ease-of-use in mind. Only TA Instruments' DHR offers the convenience and versatility of Smart Swap™ geometries, temperature systems, and accessories. Smart Swap™ technologies provide fast and easy interchanging of accessories and automatic detection and configuration of the rheometer for operation.

Note: For more information see also the Discovery Hybrid Rheometer Brochure

DHR Temperature Systems & Accessories

Peltier Plate Temperature Systems	6
Peltier Plate Accessories	14
Upper Peltier Plate	16
Peltier Concentric Cylinders	20
Pressure Cell	26
High Sensitivity Pressure Cell	28
Electrically Heated Concentric Cylinder (EHC)	30
Electrically Heated Plate	32
Environmental Test Chamber	34
Dynamic Mechanical Analysis	38
Orthogonal Superposition	42
Powder Rheology	44
Modular Microscope	46
Optical Plate	48
Small Angle Light Scattering	50
Interfacial Accessories	52
Tribo-Rheometry Accessory	56
Magneto-Rheology	58
Relative Humidity	60
Electro-Rheology	62
UV Curing Accessories	64
Rheo-Impedance Spectroscopy	66
Dielectric Analysis	68
Immobilization Cell	70
Starch Pasting Cell	72
Rheo-Raman	74

The **WORLD'S HIGHEST PERFORMING RHEOMETERS**

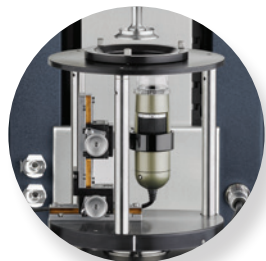

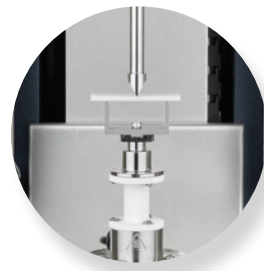
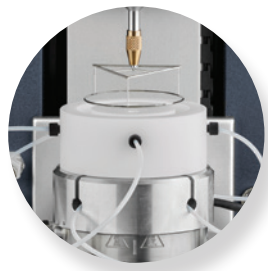

and the **MOST COMPLETE** range of
EASY-TO-USE ACCESSORIES

ADVANCED PELTIER PLATE | TEMPERATURE SYSTEM

New Advanced Peltier Plate

The Advanced Peltier Plate (APP) **combines ultimate flexibility with exceptional temperature performance** in a single Peltier Plate temperature system designed to cover the widest range of applications. The testing temperature range can be extended to 200 °C with the new High Temperature-Advanced Peltier Plate (HT-APP) when paired with the Upper Peltier Plate (UPP). This allows users to make rheological measurements in a rugged, reliable and accurate manner. The unique Quick Change Plate system provides the ability to easily attach lower plates of different materials and surface finishes, disposable plates for testing curing materials, and an Immersion Cup for characterizing materials in a fluid environment.

Features and Benefits

- Smart Swap™ technology
- Wide temperature range: -40 °C to 200 °C*
- Accurate temperature control: ± 0.1 °C
- Plates and cones up to 50 mm in diameter
- Robust hardened finish
- Quick Change Plates provide flexibility for modifying lower geometry surface
 - Stainless steel, Anodized Aluminum and Titanium plates
 - Smooth, Sandblasted and Crosshatched plates
 - Disposable plates available for curing materials
- Fully accessorized
 - Extremely efficient Solvent Trap to eliminate solvent loss during experiments
 - Immersion Cup
 - Camera Viewer option

* Testing up to 200 °C requires HT-APP with the UPP





stepped Plate



sandblasted Plate



Disposable Plate

Quick Change Plates

The Advanced Peltier Plate's simple bayonet-style locking ring facilitates the effortless attachment of a wide range of different lower plate covers. The available Quick Change Plates include hard-anodized aluminum, titanium and stainless steel plates with smooth, sandblasted or crosshatched surface finishes. Standard disposable aluminum plates expand the capabilities of the system to test curing materials using a single Peltier Plate.



8 mm Stainless Steel



20 mm Disposable Aluminum



25 mm Crosshatched Aluminum



40 mm Anodized Aluminum



40 mm Sandblasted



50 mm Titanium

Immersion Cup

The Advanced Peltier Plate's Immersion Cup adds the capability of characterizing material properties when completely immersed in a fluid. It is easily attached to the top of the Advanced Peltier Plate through the bayonet fixture and gives access to the sample for loading, trimming, and subsequent sealing and filling – a rubber ring provides the fluid seal. The Immersion Cup is ideally suited for investigating hydrogel materials and can accommodate plates or cones up to 40 mm in diameter.



PELTIER PLATE | TEMPERATURE SYSTEM

Complete Peltier Plate Temperature Systems

Over 20 years ago, TA Instruments first introduced Peltier Plate temperature control to rheometers. Since then, this core technology has been continuously developed and adapted to meet the expanding needs of our customers. With superior technology designed into five convenient Smart Swap™ models, we offer the highest performing, most versatile, and best accessorized Peltier Plate Temperature Systems available.



Standard Peltier Plate

The Standard Peltier Plate is the most common selection, offering an 80 mm diameter hardened surface to accommodate up to 60 mm upper plates for maximum sensitivity.

Stepped Peltier Plate

The Stepped Peltier Plate provides the convenience of interchanging plate diameters and surfaces up to 25 mm in diameter or for remote sample preparation. Stainless steel and titanium plates are available in flat, sandblasted, and crosshatched finishes.

Stepped Disposable Peltier Plate

The Stepped Disposable Peltier Plate is ideal for thermoset curing or other single-use applications and is compatible with standard disposable plates.

Dual Stage Peltier Plate

The Dual Stage Peltier Plate is the perfect choice for applications requiring sub-ambient temperature control. The unique design uses a stacked Peltier element approach, enabling fast and easy temperature control down to an unprecedented -45 °C, without the use of expensive circulators.

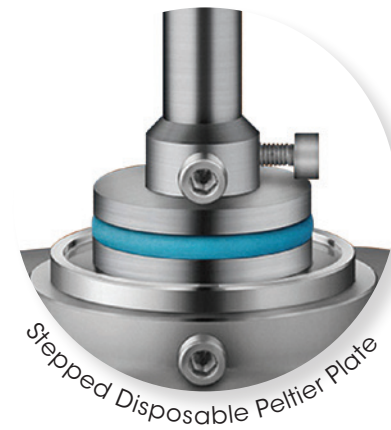
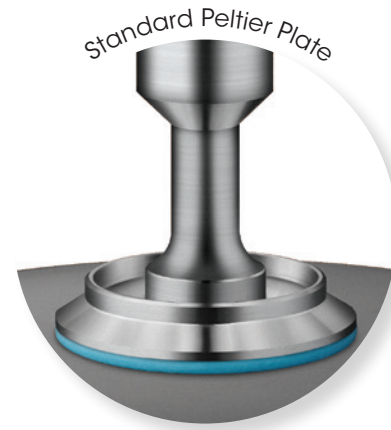

PELTIER PLATE | TECHNOLOGY

Peltier Technology

Advanced, Standard and Stepped Peltier Plates offer a temperature range of $-40\text{ }^{\circ}\text{C}^*$ to $200\text{ }^{\circ}\text{C}$, heating rates up to $50\text{ }^{\circ}\text{C}/\text{min}$, and temperature accuracy of $0.1\text{ }^{\circ}\text{C}$. Four Peltier heating elements are placed directly in contact with a thin, 80 mm diameter, copper disc with an extremely rugged, hardened surface. A platinum resistance thermometer (PRT) is placed at the exact center, ensuring accurate temperature measurement and control. The unique design provides for rapid, precise, and uniform temperature control over the entire 80 mm diameter surface. This allows for accurate testing with standard geometries up to 60 mm in diameter.

*with appropriate counter-cooling

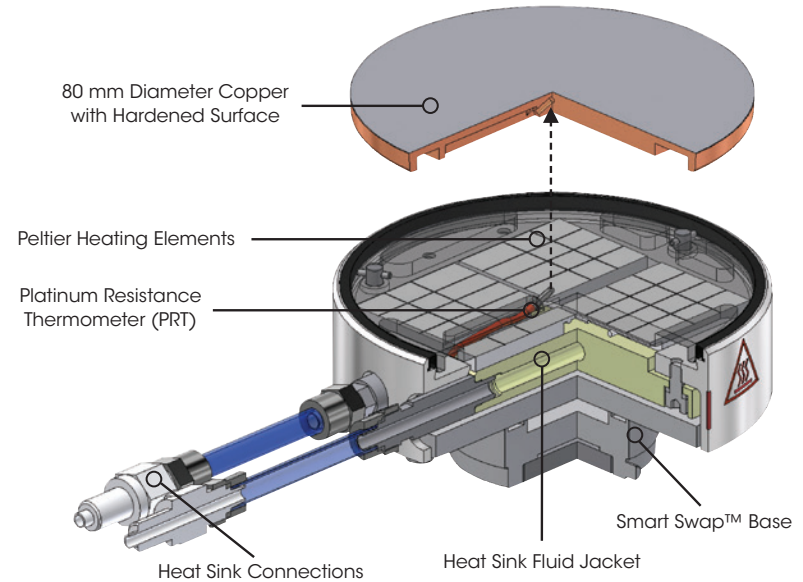

Dual Stage Peltier Plate Design

The Dual Stage Peltier Plate features an innovative design that offers a temperature range of $-45\text{ }^{\circ}\text{C}$ to $200\text{ }^{\circ}\text{C}$ with standard counter-cooling options. It integrates a unique stacked Peltier element configuration that provides enhanced low temperature responsiveness and continuous temperature control over the entire operating range with a single heat sink temperature of $2\text{ }^{\circ}\text{C}$. This eliminates the need to have expensive powerful circulators to obtain temperatures down to this range.

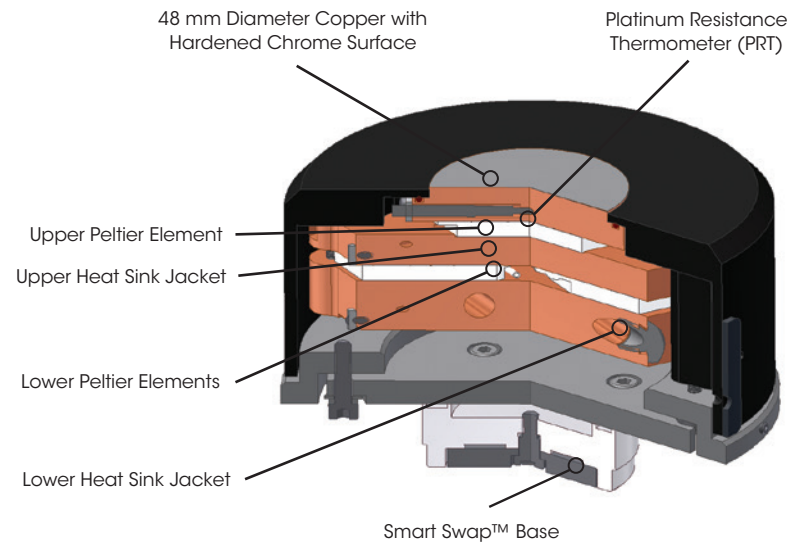

Performance

Peltier temperature control devices require that they be connected to a heat sink, typically a circulating fluid medium such as water. Most Peltier systems have a continuous temperature range of approximately 100 °C for a single heat sink temperature. The unique design of the Dual Stage Peltier Plate from TA Instruments extends the continuous operation range and dramatically improves cooling performance, especially at the low temperature limit. The figure in the lower right shows that this device can reach -40 °C from room temperature in under 10 minutes with a heat sink set at 2 °C.

Features and Benefits

- Smart Swap™ technology
- Wide Temperature Range: -45 °C to 200 °C
- Widest Continuous Temperature Range
- Accurate Temperature Control: ± 0.1 °C
- Hardened Chrome Surface
- Standard, Stepped, and Dual Stage Models
- Plates and Cones up to 60 mm in Diameter
- Disposable Plates
- Large Variety of Geometry Materials and Types
- Fully Accessorized
 - Extremely Efficient Solvent Trap
 - Smooth, Crosshatched, and Sandblasted Covers
 - Purge Gas Cover
 - Insulating Thermal Cover
 - Camera Viewer Option
 - Immersion Cell

Peltier Plate Temperature Steps over 220 °C Range

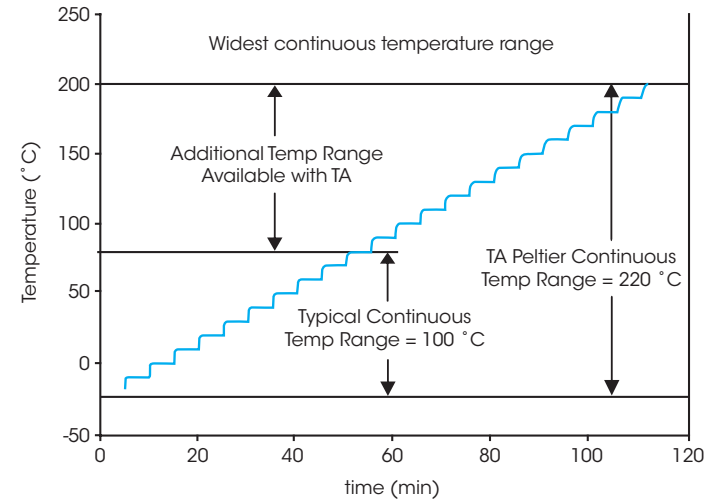

Dual Stage Peltier Plate Cooling Test

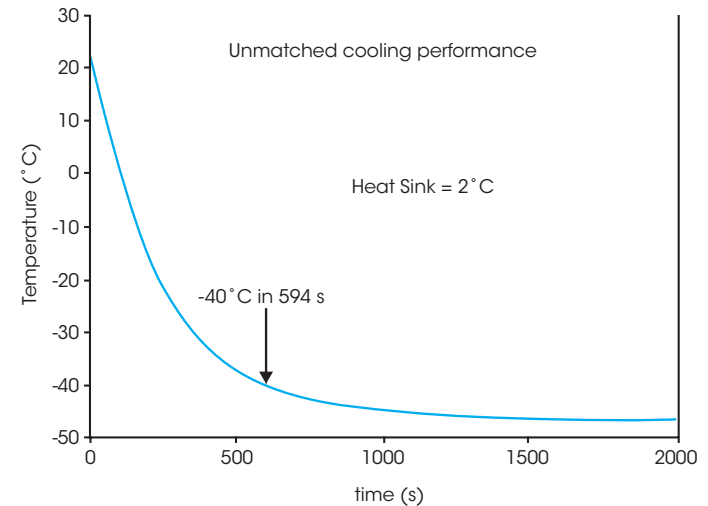

PELTIER PLATE | GEOMETRIES

Smart Swap™ 2 Peltier Plate Geometries

Peltier plates can be used with an extensive range of TA Instruments unique Smart Swap™ 2 geometries (1) with automatic recognition. Cones and plates come standard in a variety of sizes, cone angles and material types. Custom geometries of non-standard sizes, materials, and surface finishes (such as sandblasted or Teflon®-coated) are available upon request.

(1) U.S. Patent # 6,952,950



Standard Geometry Dimensions

Peltier Plate geometries are available in 8 mm, 20 mm, 25 mm, 40 mm, 50 mm, and 60 mm diameters. Upper Cone geometries are readily available in 0.5°, 1°, 2°, and 4° cone angles. Non-standard diameters and cone angles are available upon special request. By changing diameter and cone angle, the measurable range of stress and strain or shear rate can be varied to capture the widest range of material properties.



Materials of Construction and Surfaces

Peltier Plate geometries come standard in the following materials:

Stainless Steel: Rugged, very good chemical resistance for highly basic or acidic materials

Stainless Steel with Composite Heat Break: Same properties as stainless steel with added benefit of composite heat break, which insulates upper geometry when controlling temperatures away from ambient

Hard-Anodized Aluminum: Excellent thermal conductivity, low mass, fair chemical resistance

Titanium: Low mass, excellent chemical resistance

The geometry's surface finish can have an effect on wall slip phenomena. Such experimental artefacts can be mitigated by choosing the appropriate surface - a choice of smooth, sandblasted, and crosshatched are available.

Peltier Plate Standard Geometry Types

Peltier Cone and Peltier Plate geometries are available in three basic types. They include geometries without solvent trap, geometries with insulating composite heat break, and geometries with solvent trap. Heat break geometries are available in stainless steel only. Solvent trap geometries are designed for use with the solvent trap system discussed separately. The figure to the right shows a comparison of stainless steel 40 mm geometry types.



Eliminating Wall Slip on Toothpaste with Crosshatched Plates

Wall slip phenomena can have large effects on steady shear rheological measurements. To mitigate such issues, a roughened surface finish is typically used. The figure to the right shows the steady state flow testing results on toothpaste with smooth and crosshatched plate geometries. With this type of material, standard smooth surface plates slip at the interface and lead to a false measured yield stress on the order of about 18 Pa. However, with crosshatched geometries, slip is eliminated and an accurate yield stress of 105 Pa, which is more than 5 times higher, is measured.

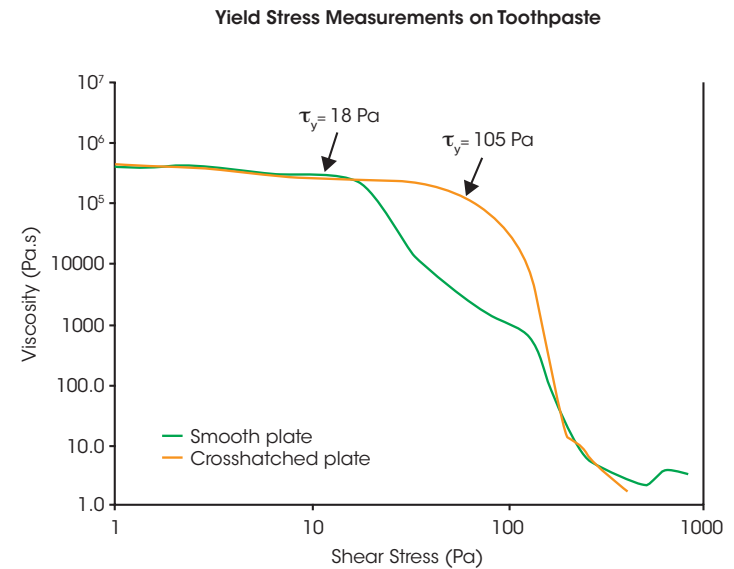

PELTIER PLATE | ACCESSORIES

Peltier Solvent Trap and Evaporation Blocker

The Solvent Trap cover and Solvent Trap geometry work in concert to create a thermally stable vapor barrier, virtually eliminating any solvent loss during the experiment. The geometry includes a well that contains very low viscosity oil, or even the volatile solvent present in the sample. The Solvent Trap cover includes a blade that is placed into the solvent contained in the well without touching any other part of the upper geometry. The performance of the solvent trap cover is shown in the data to the right for water at 40 °C. The Solvent Trap sits directly on top of the Peltier Plate surface and an insulating, centering ring ensures perfect placement for quick and easy sample loading. The solvent trap is also available in an insulated model. See Insulating Thermal Covers section for details.

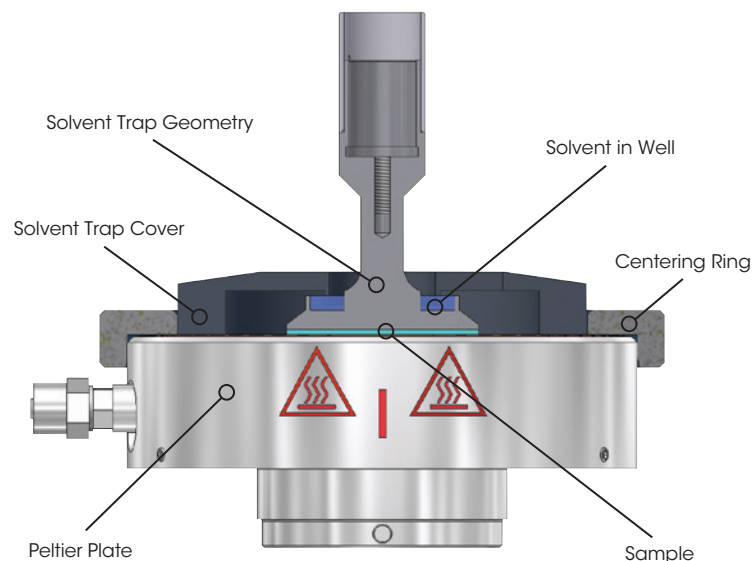
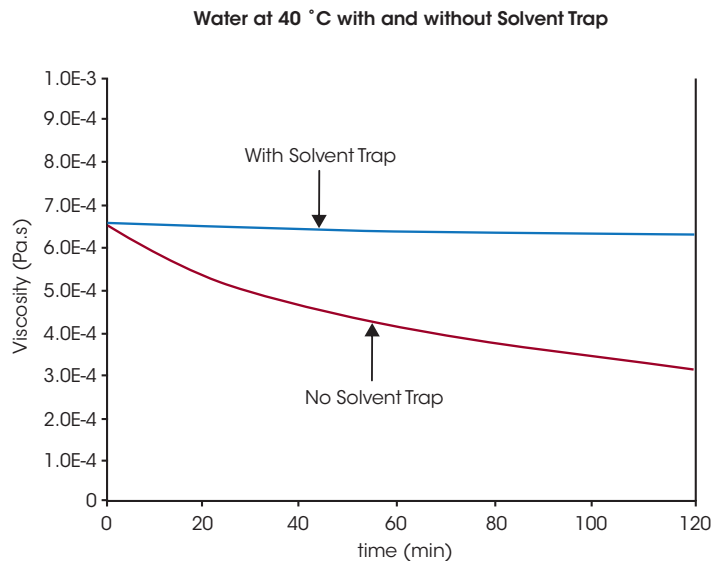

Purge Gas Cover

The Purge Gas Environmental Cover is a hard-anodized aluminum two-piece split cover with 4 mm diameter compression fittings. An insulating location ring ensures precise and easy location of the cover. This cover is ideal for purging the sample area with nitrogen to prevent condensation during experiments performed below room temperature or with a humidified purge to keep a sample from drying.

Insulating Thermal Covers

Thermal Insulation Covers are constructed of an anodized aluminum core surrounded by an insulating exterior. The aluminum core conducts heat to the upper geometry, providing uniform temperature throughout the sample. The cover is available in standard and solvent trap models. The standard cover accommodates up to 25 mm plates and can be used with the Standard, Stepped, and Disposable Peltier plate models. It is recommended for use over a temperature range of -10 °C to 90 °C, with samples not susceptible to drying such as oils, caulk, epoxy, and asphalt binder.

The Insulated Solvent Trap cover is available for both the Advanced and Standard Peltier plates and supports geometries up to 50 and 60 mm diameter respectively. It is recommended for testing low viscosity materials over the same temperature range as the thermal covers and offers the added benefit of preventing evaporation. Heat break geometries are recommended for use with insulating covers.

Peltier Immersion Ring

The Peltier Plate Immersion Ring allows samples to be measured while fully immersed in a fluid. The immersion ring is compatible with all Peltier Plate models and is easily attached to the top of the Peltier Plate. A rubber ring provides the fluid seal. This option is ideal for studying the properties of hydrogels.

Peltier Plate Covers

A variety of Peltier Plate Covers are available for applications that can harm the surface of the plate or for samples that exhibit slip during testing. They are available in stainless steel, hard-anodized aluminum and titanium. Crosshatched and sandblasted Peltier covers are used to eliminate sample slippage effects. Covers are compatible with solvent trap.

Peltier Plate Camera Viewer

The camera viewer is used in conjunction with streaming video and image capture software. Real-time images can be displayed in the software and an image can be stored with each data point for subsequent viewing during data analysis. The camera viewer is perfect for long experiments with unattended operation for visual inspections of data integrity.



UPPER PELTIER PLATE | TEMPERATURE SYSTEM

Upper Peltier Plate (UPP)

The Upper Peltier Plate (UPP) is a temperature control system vital for rheological measurements when testing at temperatures away from ambient, especially in the adhesives, asphalt, pharma, and personal care industries, to name a few. The UPP utilizes fast-responding Peltier elements to ensure a uniform temperature profile throughout the entire sample. Measurement errors upwards of 40% can occur when limiting temperature control to one side of the sample, even at 40 °C. This error only grows when moving further away from ambient. When used in conjunction with lower Peltier plates, the UPP's simple and easy-to-use configuration delivers fast and precise temperature control above and below the sample, eliminating measurement errors in viscosity, yield stress, viscoelastic behavior (G' , G'' , and $\tan \delta$), and other rheological data. Apart from delivering unparalleled accuracy, the quick-responding Peltier technology allows the use of fast heating rates typically used in convective ovens, delivering data agreement between different rheometer and temperature system configurations.

The UPP is the only Peltier-based upper heater technology with direct temperature measurements at the sample, made possible through TA's patented active temperature control (ATC)(1). This technology combines with TA's patented heat spreader technology(2) to drive heat directly to the sample for the most accurate temperature control and material characterization from -40 °C to 200 °C, meeting a wide range of testing needs.

(1) U.S. Patent # 6,931,915

(2) U.S. Patent # 7,168,299

Advanced Peltier Plate



Active Temperature Control (ATC) Technology

Patented Active Temperature Control (ATC) provides non-contact temperature sensing for active measurement and control of the upper testing surface. A Platinum Resistance Thermometer (PRT) is housed within the special ATC draw rod. This PRT is positioned in intimate contact with the center of the upper measurement surface. The temperature signal is then transmitted wirelessly to the instrument controller enabling direct control and feedback based on the actual upper plate temperature. Because the upper plate temperature is measured and controlled directly, the system has many advantages over traditional systems which require the sample temperature to be inferred from complex calibration procedures and offset tables. **Together with the PRT in the lower plate, real-time control of both plates allows temperature to be changed at both surfaces at the same rate for true temperature ramp profiles.**

Features and Benefits

- Patented heat spreader conducts heat directly to sample, creating a uniform sample temperature and eliminating measurement errors.
- Fast-responding temperature control driven by Peltier elements for improved productivity.
- Wide operating temperature range from -40 °C to 200 °C* in a simple and compact configuration without liquid nitrogen or mechanical chillers
- Direct sample temperature measurement with patented ATC delivers unmatched data reproducibility with oven systems (ETC and FCO).
- Protect samples from environmental influences:
 - Solvent reservoir option: prevents evaporation for aqueous and volatile samples
 - Thermal shield: protects from moisture condensation
 - Gas purge ports: prevent degradation with inert atmosphere
- Compatible with additional accessories to meet every testing need:
 - All Peltier plates, including disposable and screw-in plates
 - UV curing accessories
 - Modular microscope (MMA)
 - Optics plate accessory (OPA)

* Testing up to 200 °C requires HT-APP with the UPP

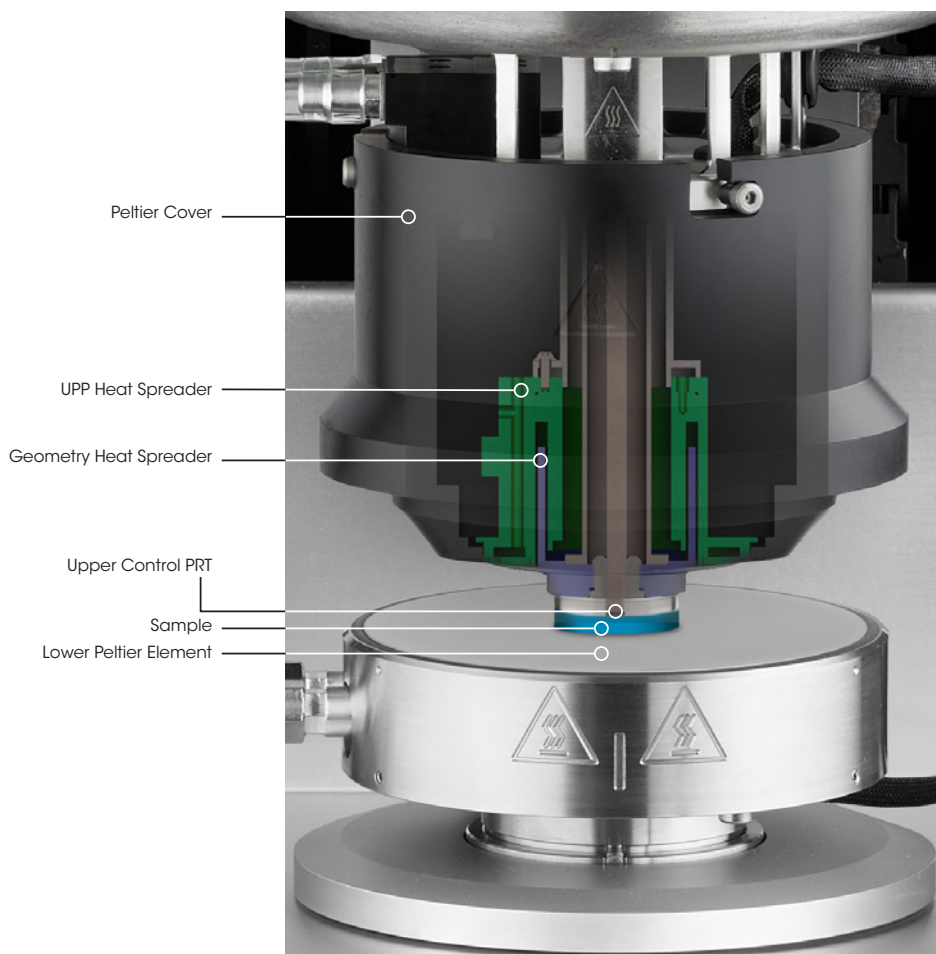

Fast and accurate temperature response with the UPP

The true test of any rheometer temperature control system is to compare sample response to the reported system temperature.

A silicone oil viscosity standard is measured as the temperature is incrementally stepped from 50 °C to 105 °C. The measured temperature quickly equilibrates to the new setpoint temperature within a few minutes. Thermocouples are specifically located at the sample to provide the most accurate temperature measurement, while responsive Peltier elements quickly and precisely respond to new setpoint temperatures. As a result, the complex viscosity of the sample exactly follows the reported temperature profile. This direct relationship indicates that there is absolutely zero lag between set-point and real sample temperature, resulting in confidence in every measurement.

According to federal standards, a sample of asphalt binder needs to be fully equilibrated to within 0.1 °C of the test temperature prior to performing rheological measurements. In the plot shown below, the temperature quickly and accurately jumps from 25 °C to 85 °C within minutes of starting the experiment. The data further shows that as soon as the temperature is within 0.1 °C, the viscosity of the asphalt binder is fully equilibrated. No change is seen in the viscosity even after 20 additional minutes indicating that there is minimal lag between the set-point and real sample temperature.

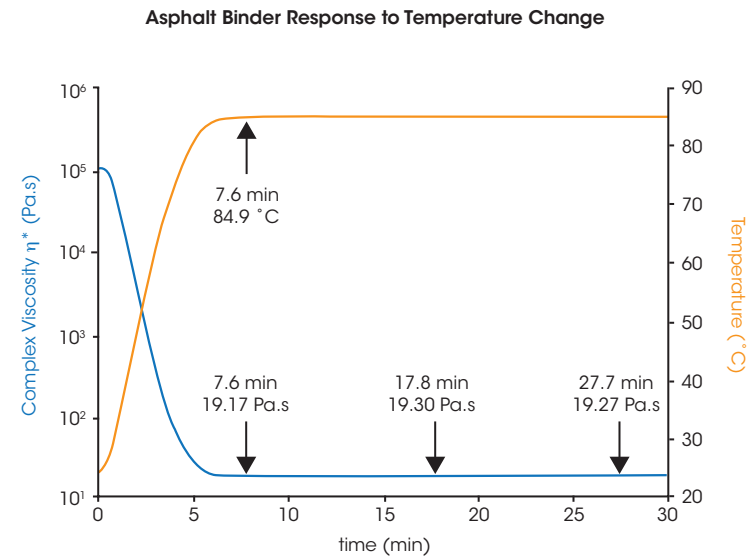
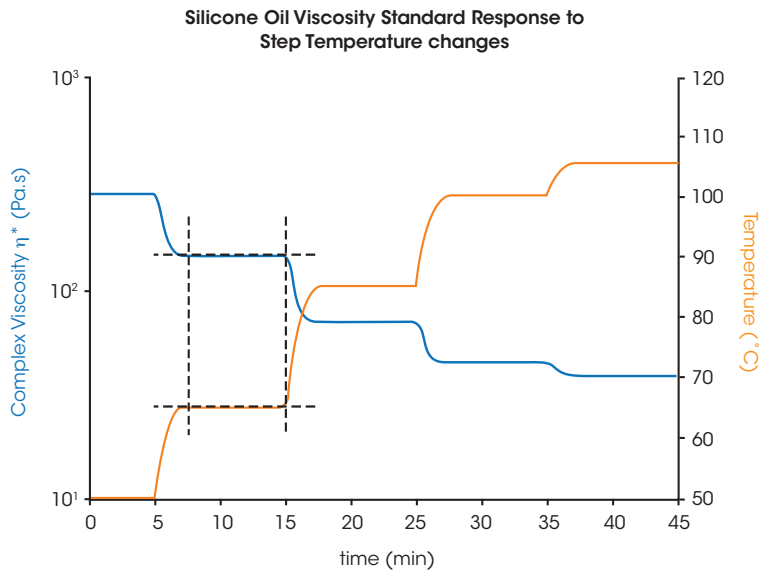

Plastisol Curing with UPP and ETC

Rheology data is often used to optimize processing conditions, such as identifying operating temperatures, molding cycle times, annealing and many others. Even small errors in temperature, especially non-uniform sample temperatures, lead to erroneous data, the implementation of incorrect processing conditions, and ultimately poor product performance.

The plot shows a temperature ramp on a plastisol using three temperature system configurations, a combined convection-radiation oven (ETC), a lower Peltier Plate only, and a lower Peltier Plate with the Upper Peltier Plate (UPP). A uniform temperature profile in the sample is achieved when the sample is heated from both the top and bottom, as in the ETC and UPP. Data from both configurations exactly match and show the hardening temperature, observed as a sharp increase in G' , occurs at approximately 60 °C. However, when heating the sample using only the lower Peltier Plate, the sample temperature lags the heating profile resulting in a temperature gradient in the sample. This results in what appears to be a delayed onset of curing at approximately 70 °C. The UPP's direct temperature control enables users to obtain accurate and precise rheological measurements and unmatched data repeatability, even when compared to different temperature system configurations across their organization.

Characterization of adhesives

An adhesive's success and suitability hinges on its ability to bond and resist debonding from a substrate. Measuring the viscoelastic properties, such as G' , G'' and $\tan \delta$, allow users to quantify performance characteristics such as cohesive strength, tack, and operating temperature range. For example, the performance window of a pressure-sensitive adhesive (PSA) is highly sensitive to the T_g which defines the lowest use temperature of the PSA.

In this PSA example, an oscillation temperature ramp test was performed at 5 °C/min. The peak of the $\tan \delta$ signal is used to determine the T_g of the material at 6.90 °C, indicating the lowest use temperature. The G' and G'' signals provide quantitative metrics of the cohesive strength and tack of the material from -30 °C to 200 °C. The tack and peel behavior can be further studied using frequency sweeps at the end-use temperatures.

The UPP's simple configuration delivers accurate temperature control, even at sub-ambient temperatures without needing liquid nitrogen or mechanical chillers.

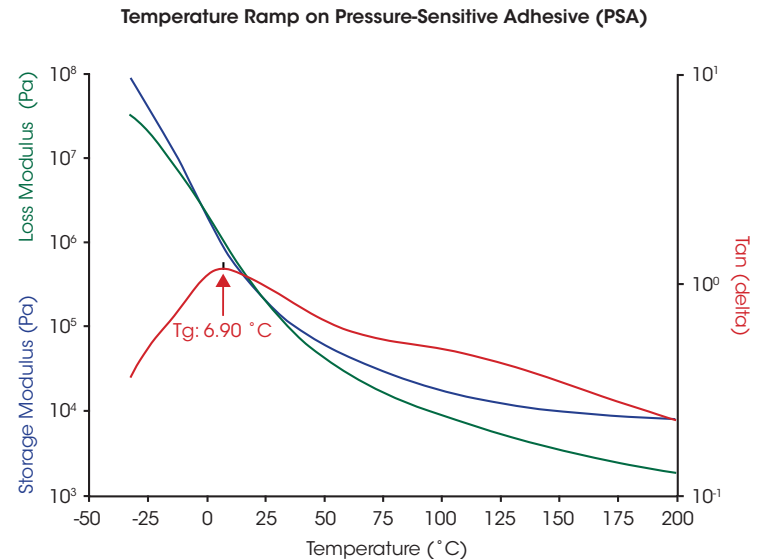
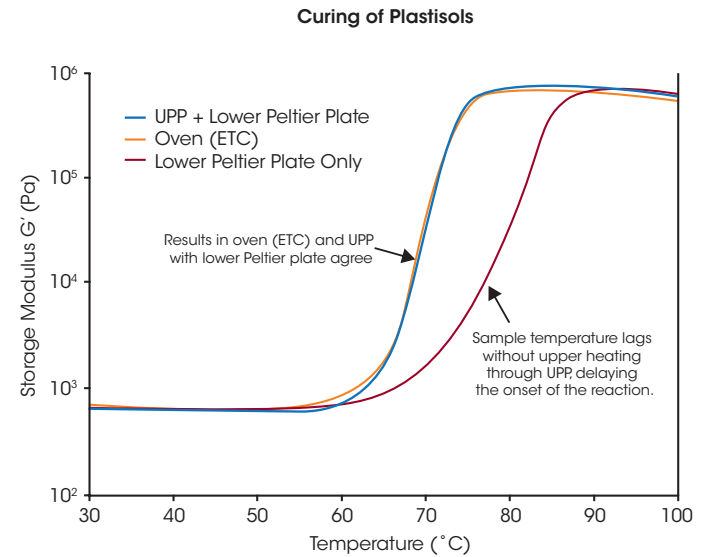

PELTIER CONCENTRIC CYLINDER | TEMPERATURE SYSTEM

Peltier Concentric Cylinder Temperature System

The Peltier Concentric Cylinder Temperature System combines the convenience of Smart Swap™ and Peltier heating technology with a wide variety of cup and rotor geometries. Concentric Cylinder geometries are commonly used for testing low viscosity fluids, dispersions or any liquids that are pourable into a cup. Examples of materials suitable for Concentric Cylinder include low concentration polymer solutions, solvents, oils, drilling mud, paint, varnish, inkjet ink, ceramic slurries, pharmaceutical suspensions, cough medicine and baby formula, foams, and food and dairy products such as milk, sour cream, juices, salad dressings, and pasta sauce.

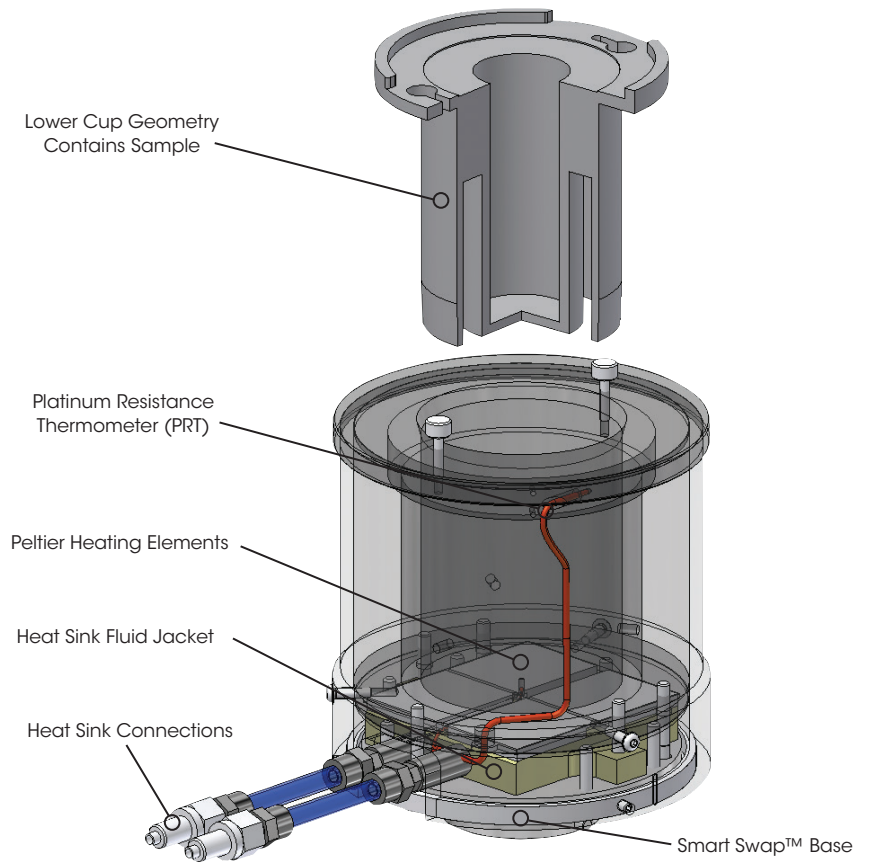
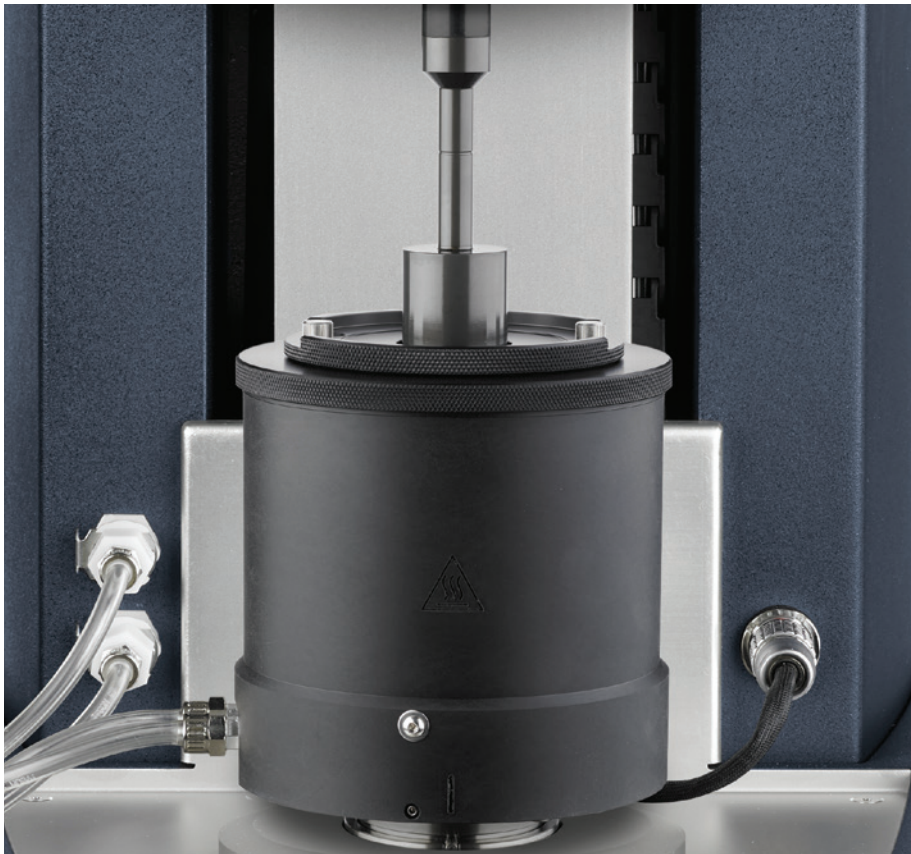

Technology

The Peltier Concentric Cylinder system offers a temperature range of $-20\text{ }^{\circ}\text{C}$ to $150\text{ }^{\circ}\text{C}$, with a maximum heating rate up to $13\text{ }^{\circ}\text{C}/\text{min}$. Four Peltier heating elements are placed in intimate contact with a lower cup geometry held in place by an insulated jacket. The unique patented design⁽¹⁾ of the lower geometry provides fast and efficient heat transfer up the walls of the cup. A platinum resistance thermometer (PRT) is placed close to the top of the cup ensuring accurate temperature measurement and control. The maximum controllable heating rate will depend on heat sink fluid temperature, circulator flow rate and cooling/heating capacity, and viscosity of heat sink fluid.

(1) U.S. Patent # 6,588,254

Cup and Rotor Geometries

The standard Peltier Concentric Cylinder geometries include a cup radius of 15 mm, configured with either a Recessed End or DIN Rotor. Both rotors have a radius of 14 mm and height of 42 mm. The double gap concentric cylinder has an additional shearing surface over single gap providing lower stress and higher sensitivity for extremely low viscosity solutions.

Special Cups and Rotors

Specialty geometries include various vanes, helical, and starch pasting impeller rotors, as well as large diameter and grooved cups. These special concentric cylinder geometries are very valuable for characterizing dispersions with limited stability, preventing error from slip at the material/geometry interface, and for bulk materials with larger particulates. Vane geometries are available in both 14 mm and 7.5 mm radii. The large diameter cup has a radius of 22 mm. The helical and impeller rotor and cup keep a sample mixed or particles suspended during shearing. Disposable cups are ideal for increasing test throughput when testing difficult to clean samples like inks and slurries. The cups have a radius of 16 mm and are compatible with the DIN, recessed end, vane, and wide gap vane rotors.

Features and Benefits

- Smart Swap™ technology
- Wide temperature range: -20 °C to 150 °C
- Peltier temperature control for fast heating and cooling
- Popular DIN standard, Recessed End and Double Gap Options
- Geometries available in Stainless Steel and Hard-Anodized Aluminum
- Wide variety of cup diameters
- Impeller and Vane geometries for preventing settling and slipping, and handling of large particles
- Torsion Immersion
- Special geometries available upon request
- Disposable cups for high throughput testing



Concentric Cylinder Cup and Rotor Compatibility Chart

Cup \ Rotor	Rotor							
	DIN	Recessed End	Starch Impeller	Vane	Wide Gap Vane	Double Gap	Helical Rotor	
Standard (rad= 15 mm)	•	•		•	•			
Large Diameter (rad= 22 mm)	•	•	•	•	•		•	
Starch (rad= 18.5 mm)	•	•	•	•	•		•	
Grooved				•	•			
Double Gap						•		
Helical (rad= 17 mm)							•	
Disposable Cup (rad= 16 mm)	•	•		•	•			

CONCENTRIC CYLINDER | ACCESSORIES & APPLICATIONS

Generic Container Holder

The Generic Container Holder is a Smart Swap™ option that can hold any container with an outer diameter of up to 80 mm for characterizing materials with rotors. This allows for quick off-the-shelf evaluation of materials, such as paints and varnishes, creams, pasta sauce, etc., without creating large shearing from sample loading. It also is an excellent platform for beakers or jacketed beakers.

Flow Curve on Xanthan Gum

Concentric cylinder geometries are useful for gathering viscosity flow curve information over a wide range of shear rates. An example is shown in the figure for a xanthan gum solution. Five decades of viscosity are easily obtained over six decades of shear rate. This system is also a powerful alternative to parallel plate or cone and plate geometries for materials with limited stability or prone to edge failure or rapid solvent evaporation.

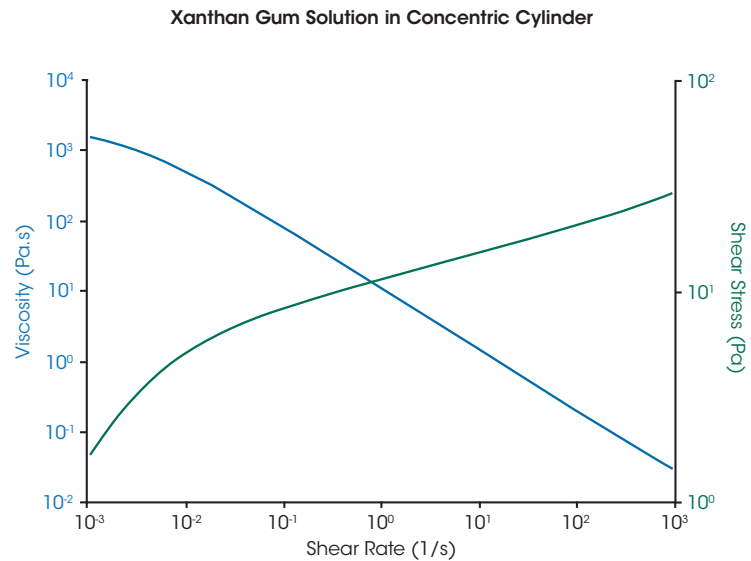

Concentric Cylinder Solvent Trap Cover

A Solvent Trap is available for the Peltier Concentric Cylinder. It includes a base reservoir and a two-piece cover that is mounted to the shaft of the rotor. The Solvent Trap provides a vapor barrier to seal the environment inside the cup and prevents solvent evaporation.

Characterization of Foam with Vane Rotor

The figures below show an example of the time and frequency dependent response of a foam shaving cream characterized using a standard cup and vane geometry. The structure of shaving foam has a limited lifetime, or limited stability. The vane geometry minimizes shearing stress that occurs during loading in the gap with standard rotor, keeping the delicate foam structure intact for testing. A wide range of structural information can be captured very quickly using multiwave characterization on the DHR. The figure to the left shows a decay in storage modulus G' as the structure of the foam breaks down with increasing time. Using the multiwave, the data are simultaneously collected over a wide range of frequencies. The data can be plotted as frequency sweeps at increasing time, as shown on the right. The results show the time dependent viscoelastic response of the shaving foam.

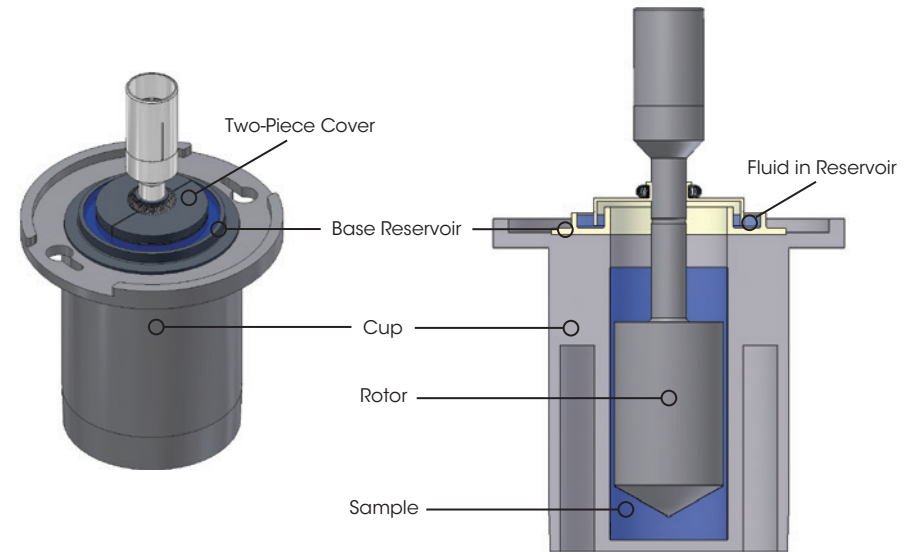

Multiwave time sweep

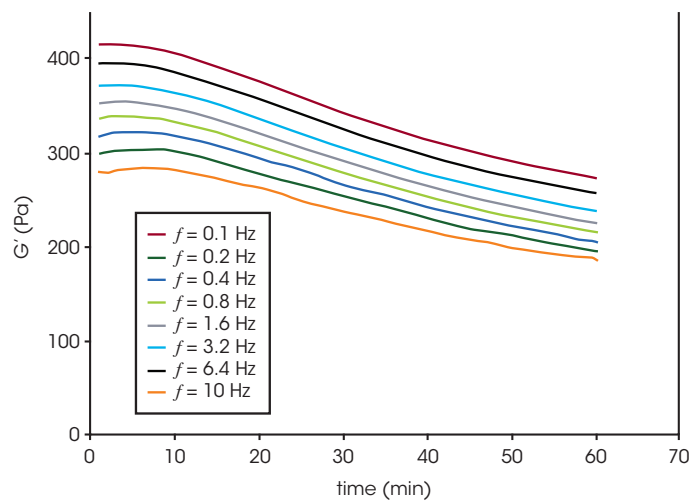

Frequency Sweeps on Foam at Different Time Intervals

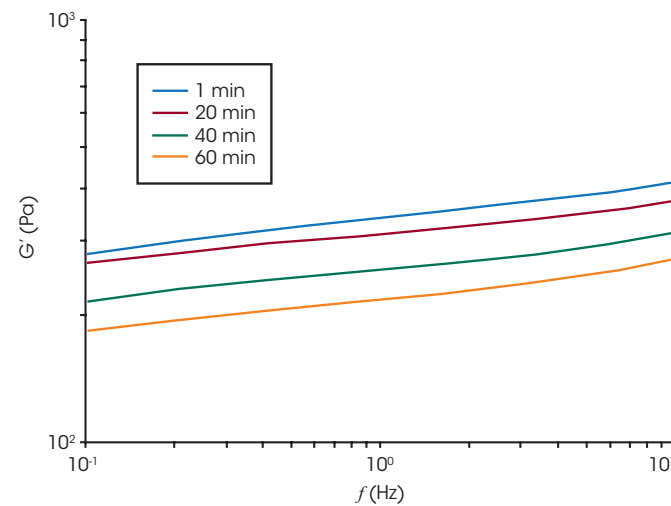

CONCENTRIC CYLINDER | ACCESSORIES

Torsion Immersion Cell

The Torsion Immersion Cell allows rectangular bar-shaped samples to be clamped and characterized while immersed in a temperature controlled fluid. The resulting change in mechanical properties, caused by swelling or plasticizing, can be analyzed in oscillatory experiments. This option provides a way to better understand materials under real-world conditions, such as body implants in saline or rubber seals in contact with oils and solvents.

Rheology of Pasta During Cooking

The Torsion Immersion Cell can be used for various food applications, such as cooking pasta. In this example, a piece of fettucine pasta was tested using an oscillatory time sweep test at 22 °C using a 1 Hz test frequency. Data were collected on the dry sample for 2.5 min to establish a baseline storage modulus, G' . The addition of water at this point introduces moisture to the sample which has an immediate effect of lowering the G' . At 5 min, the temperature was ramped to 95 °C and held isothermally. As the pasta cooks, the modulus drops by nearly three decades and then levels out when the cooking is complete.

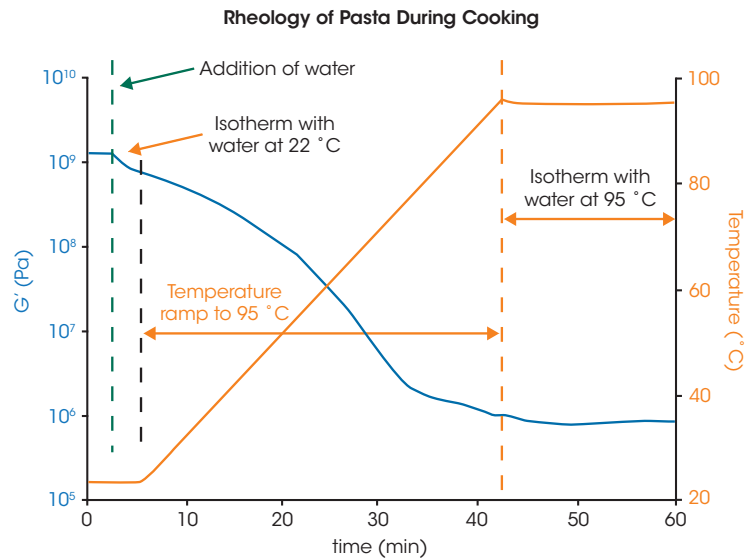

DHR Building Materials Cell

The Building Materials Cell is a specially designed, abrasion-resistant and durable concentric cylinder cup and rotor for testing samples with large particles such as concrete slurries and mixes. The paddle type rotor, slotted cage, and the large diameter cup promote adequate sample mixing while preventing sample slip at both the cup and rotor surfaces. The removable slotted cage permits easy sample cleaning after the test while the concentric cylinder Peltier jacket provides accurate temperature control. Together with the existing array of specialty rotors and cups, the new Building Materials Cell provides the ultimate flexibility for testing a diverse range of samples with large particles including construction materials and food products.

The data below follow the structural recovery of a concrete mixture tested at 25 °C using the Building Materials Cell. The concrete sample was initially subject to large deformation to mimic processing conditions encountered during pumping. A subsequent small strain fast oscillation test simulated the development of the sample's moduli following flow cessation. The results reveal a rapid increase in the material's storage modulus within 10 minutes, before ultimately reaching a plateau value.

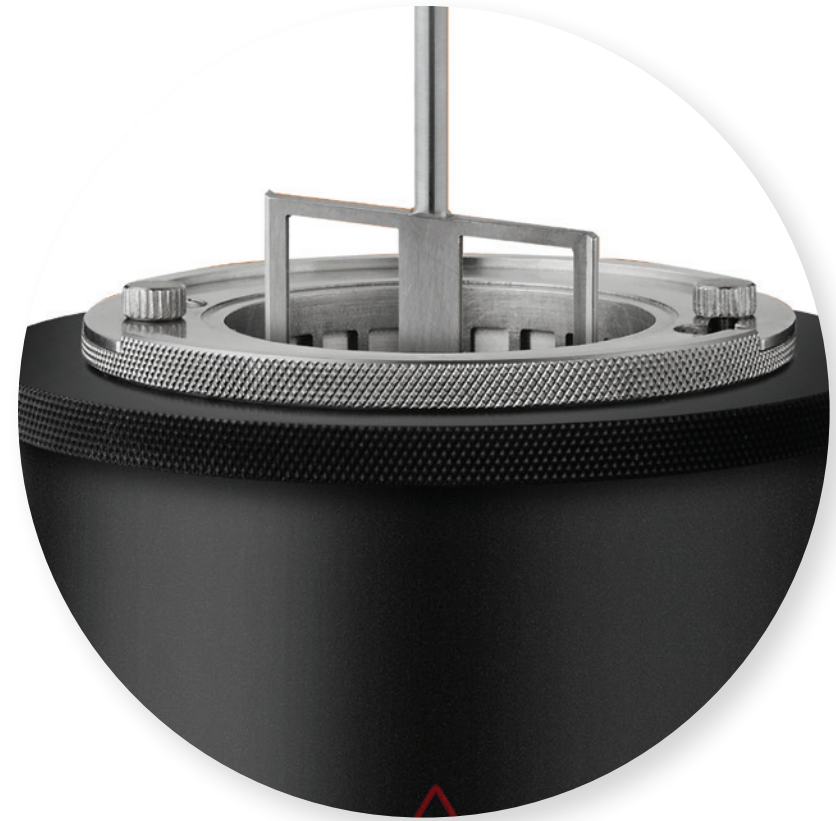

Concrete Recovery Following Pumping

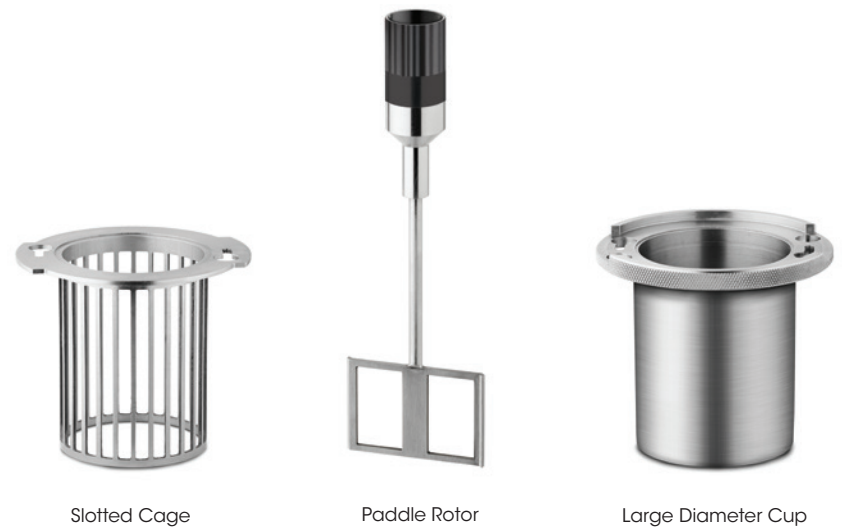
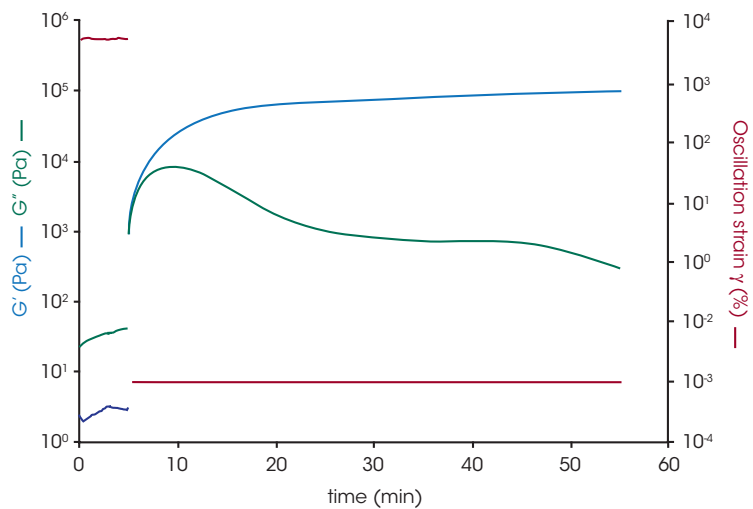

PRESSURE CELL | ACCESSORY

Pressure Cell Accessory

The Pressure Cell is a sealed vessel that can be pressurized up to 138 bar (2,000 psi), over a temperature range of -10 °C to 300 °C. It can be used either in self-pressurizing mode, in which the pressure is produced by the volatility of the sample, or by externally applying the pressurization, typically with a high pressure tank of air or nitrogen gas. The accessory includes a 26 mm conical rotor; optional vane and starch rotors are also available. All necessary plumbing and gauges are included as a manifold assembly. The Pressure Cell is ideal for studying the effect of pressure on rheological properties, as well as studying the materials that volatilize under atmospheric pressure.

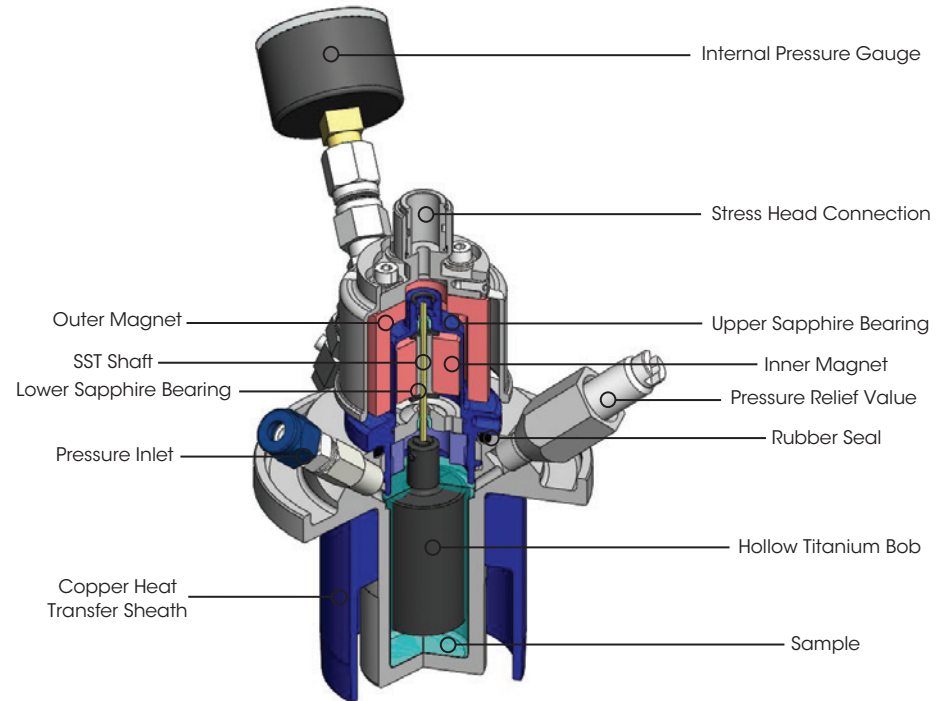

Technology

The Pressure Cell Accessory is used with the Peltier Concentric Cylinder jacket or the Electrically Heated Cylinder (EHC). The sealed and pressurized volume is contained within a stainless steel cup to withstand high pressures and is surrounded by a copper sheath for optimal heat transfer. The cup is also connected to the pressure inlet, internal pressure gauge, and pressure relief valve. An outer magnet assembly is attached to the rheometer drive shaft and houses strong rare earth magnets. The rotor assembly houses the inner magnet which couples to, and is levitated by, the outer magnet assembly and drives the hollow titanium cylindrical rotor. The rotor shaft is made from low friction Titanium nitride-coated stainless steel and is supported above and below by precision sapphire bearings. This innovative high-powered magnetic coupling and low-friction bearing design allows for both steady shear and dynamic measurements.

Pressure Cell Rotors

The Pressure Cell Accessory is compatible with any of three rotor designs. The standard rotor is the Conical Rotor, which is ideal for the quantitative measurement of liquids. Suspensions and slurries may be more well-suited to testing using the Starch Rotor, which prevents settling, or the Vane Rotor that is tolerant to larger particles and inhibits slip.



Rheology of food processing above 100 °C in Pressure Cell

Studying the rheology of materials with high water content at elevated temperatures is challenging due to evaporation. For such materials, the pressure cell accessory provides a convenient self-contained vessel where water loss due to evaporation is suppressed. The plot to the right shows a temperature ramp at constant shear rate that follows the gelatinization of pasta sauce with added corn starch. The vane geometry was used to accommodate the large vegetable pieces present in the sauce while the pressure cell provided temperature control and prevented evaporation. At low temperatures, the viscosity of the pasta sauce is low and weakly dependent on temperature. However, the onset of starch gelatinization at approximately 70 °C brings about a rapid and dramatic increase in the sample viscosity. The plot demonstrates the effectiveness of the pressure cell accessory for probing the rheology of such materials at, and above, ambient boiling temperatures.

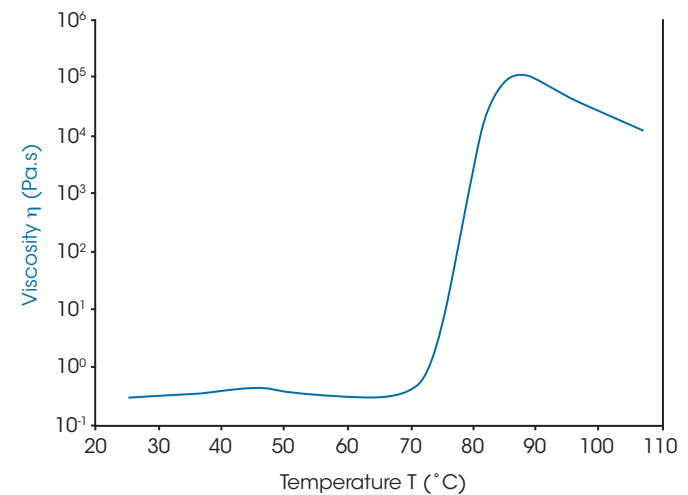

HIGH SENSITIVITY PRESSURE CELL | ACCESSORY

High Sensitivity Pressure Cell Accessory

The new High Sensitivity Pressure Cell (HSPC) for the DHR unlocks complete viscoelastic characterization of fluids in a pressurized environment. The HSPC is the only device that provides a wide range of dynamic oscillatory testing capabilities under controlled atmospheric pressure on low viscosity polymer solutions and structured fluids. Conventional pressure cells employ mechanical bearings that severely limit low torque sensitivity and make viscoelastic characterization impractical for most samples. The HSPC employs an innovative air bearing seal that allows unrivaled low torque performance with up to 100x better torque sensitivity than conventional devices, allowing users to characterize critical material behavior such as time, frequency, and strain-dependence on the widest range of fluids, including at temperatures above the boiling point of volatile components. This new range of test conditions can provide insight to material properties representative of extreme processing or use conditions, such as downhole or extrusion environments.

Features and Benefits

- Innovative, non-mechanical bearing design provides up to 100x improved torque sensitivity
- Unrivaled torque sensitivity to characterize viscoelastic behavior
- Stable and accurate temperature control from -5 °C to 150 °C with the Peltier Concentric Cylinder Jacket
- Atmospheric pressure control up to 5 bar to simulate processing and use conditions
- Completely integrated with powerful TRIOS software to directly measure and record sample pressure with rheological data
- User-friendly, self-aligning design guarantees low torque performance every time
- Available with concentric cylinder, starch rotor, and vane geometries.

Performance Specifications	
Temperature Range	-5 °C to 150 °C
Pressure Range	0 – 5 bar
Minimum Torque (Dynamic)	1 μ N.m
Minimum Torque (Steady State)	10 μ N.m
Pressurized Gas	Air or Nitrogen

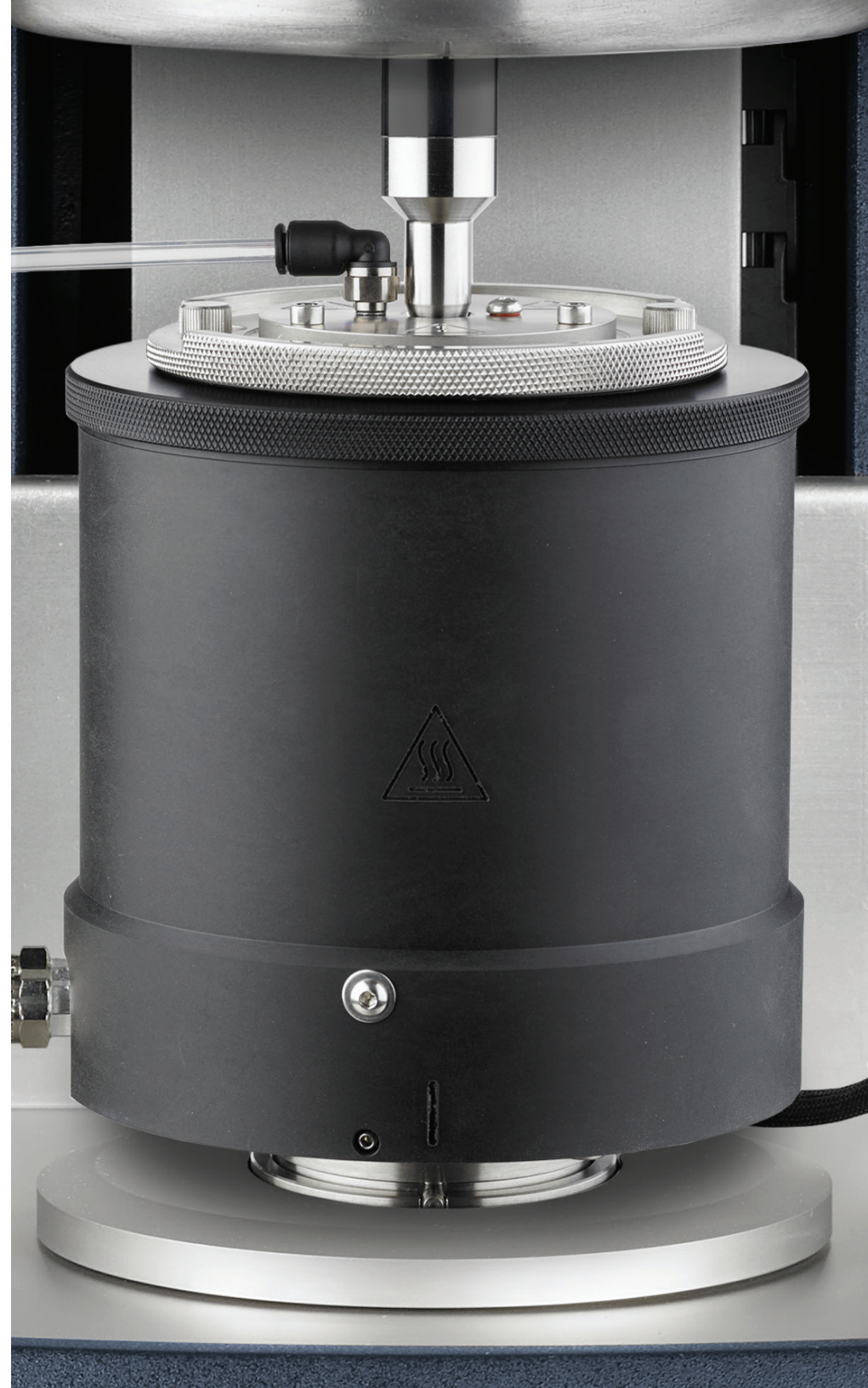

Technology

The HSPC's concentric cylinder measurement system utilizes compressed air flows and an innovative cap design to pressurize the sample volume. A self-aligning design makes the HSPC quick and easy to assemble for anyone, resulting in guaranteed low torque measurements, outstanding reproducibility, and more time for testing. Sample pressure is directly measured and saved for a complete record of the sample environment, storing all relevant test information in one convenient TRIOS data file. The High Sensitivity Pressure Cell (HSPC) extends the DHR's capabilities for studying materials under pressurized conditions to include dynamic oscillatory testing capabilities enabling the full spectrum of viscoelastic characterization.



Characterization of Xanthan Gum Solution Under Pressure

Measuring the viscoelastic properties of fluids at temperatures above boiling poses significant challenges, most notably the loss of volatile ingredients resulting in changes to material composition. Various methods and devices have been employed to trap solvents or suppress evaporation; these can delay compositional changes at higher temperatures but are ineffective beyond the boiling point. A pressurized testing environment is the only means to characterize the rheological properties of materials under such conditions.

Xanthan gum is often used as an additive for gelling and food applications. A solution of 2.5 wt% of xanthan gum in water was tested in the High Sensitivity Pressure Cell as the temperature was increased at 5 °C/min from 25 °C to 120 °C. The evolution of the dynamic moduli (G' and G'') was measured over the entire temperature range, even above the boiling temperature of water. A crossover point is clearly identified near 95 °C, indicating the transition from a gelled state to a liquid-like polymer solution. Tracking the changing viscoelastic properties and identifying important points of interest such as the modulus crossover provide insight into the full viscoelastic behavior of materials in extreme processing or use conditions.

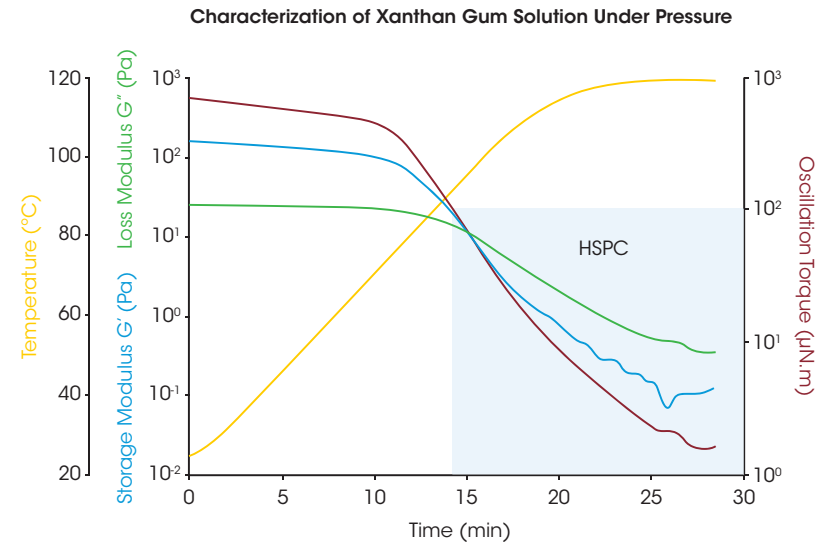

Electrically Heated Concentric Cylinder (EHC)

The Electrically Heated Concentric Cylinder system enables concentric cylinder rheological measurements over the broad range of temperatures from ambient to 300 °C. Perfect for high-temperature testing of low viscosity liquids, the Electrically Heated Cylinder also supports high-temperature and pressure studies in conjunction with the popular Pressure Cell. These combined high-pressure and temperature investigations are ideal for characterizing fluids under down-hole conditions relevant to mining and oil recovery operations.

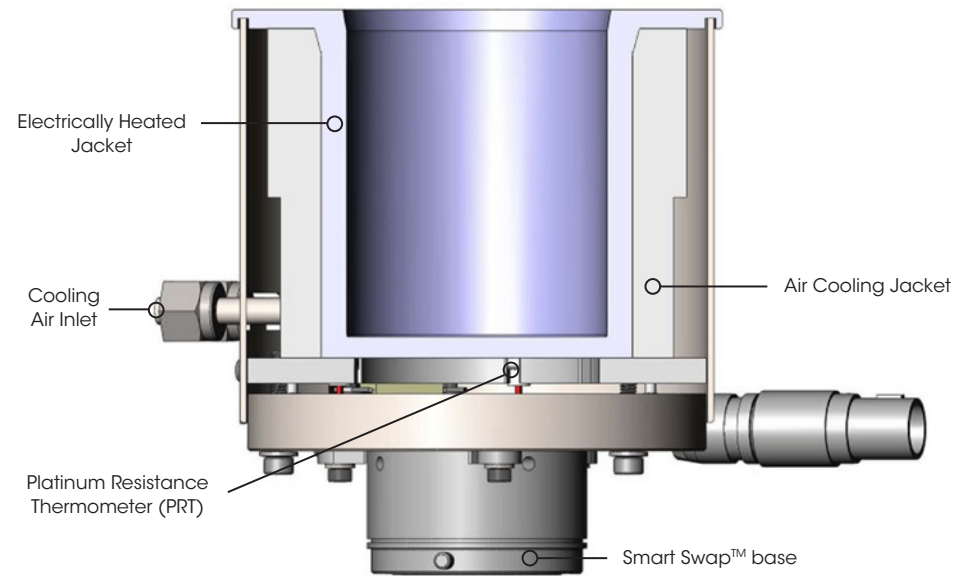

Technology

Efficient electrical heaters and optimized heat transfer ensure the most accurate and uniform temperature control available. An available air cooling system reduces cool-down time, greatly improving sample throughput without the expense of refrigerated liquid circulators.

The EHC is compatible with a wide variety of concentric cylinder cups, rotors, and accessories, including conical-end DIN rotors, recessed-end rotors, double-gap systems, solid torsion immersion, and the popular Pressure Cell.



Effect of Pressure on Motor Oil

To understand the ability of motor oil to provide necessary lubrication under different environmental conditions, it is critical to know its viscosity over a range of temperature and pressures. The figure to the right shows results of steady state flow tests conducted on automotive motor oil. The temperature was held constant and tests were run at atmospheric pressure, 1,000 psi (69 bar), and 2,000 psi (138 bar) of pressure. The results show that the pressure acts to increase internal friction, as observed by the increase in viscosity.

Features and Benefits

- Smart Swap™ technology
- Wide temperature range: ambient to 300 °C
- Powerful electrical heating for fast, accurate temperature control
- Popular DIN conical-end standard, Recessed-end and Double Gap Options
- Vane geometries and Building Materials Cell to prevent slip and handle very large particles
- Compatible with Pressure Cell Accessory to study behavior at high temperature and pressure

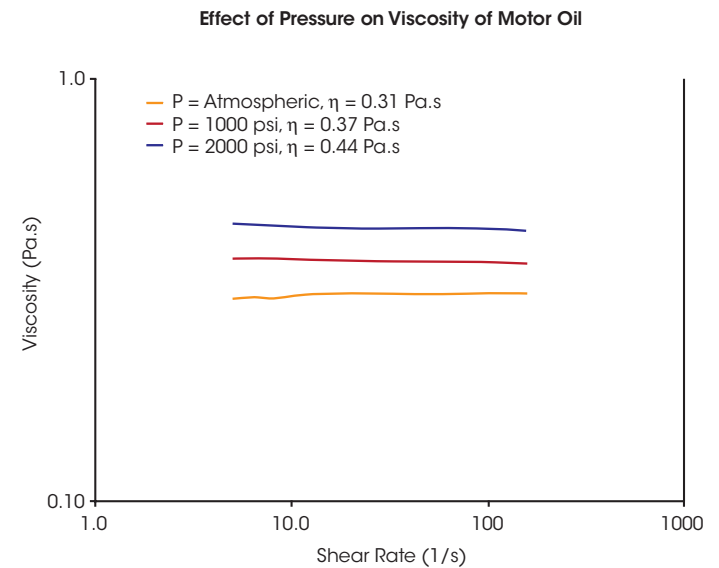

EHP | TEMPERATURE SYSTEM

Electrically Heated Plate (EHP) Temperature System

The EHP provides active heating and cooling of parallel plate and cone and plate geometries. With standard and disposable systems, it is ideal for rheological characterization of polymer melts and thermosetting materials up to a maximum temperature of 400 °C. The optional Gas Cooling Accessory extends the minimum temperature to -70 °C. Standard features include 25 mm diameter parallel plate geometry, environmental cover, and heated purge gas. An optional clear cover is available for sample viewing and for use with the Camera Viewer option. The EHP offers Active Temperature Control (ATC) making it the only electrically heated plate system capable of direct temperature control of the upper and lower plates (See ATC Section on page 16 for more details on this advanced technology). The upper EHP can be used with lower Peltier Plates for temperature control to 200 °C and as temperature control to 150 °C for UV curing options.

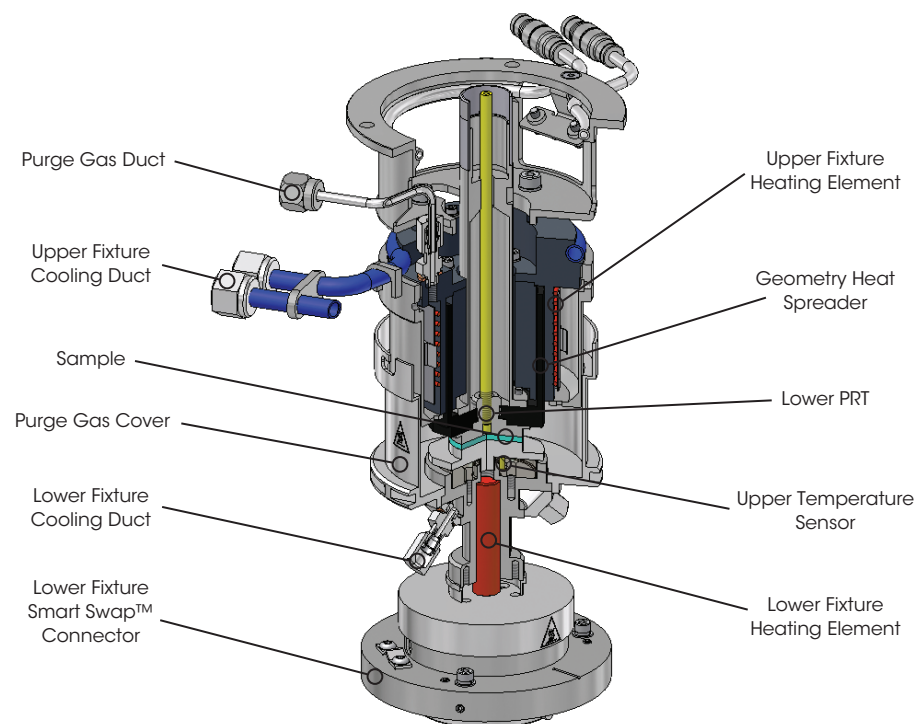

Technology

The EHP lower assembly incorporates a cartridge-heater and cooling channel directly below the lower plate. A Platinum Resistance Thermometer (PRT) is positioned at the center and is in contact with the opposite face of the lower plate, providing intimate measurement and control of the sample temperature. In the upper assembly, a cylindrical heat transfer unit, with an integrated electric heater and a liquid/gas cooling channel, surrounds the cylindrical heat spreader geometry. These two components are in very close proximity, but do not contact, enabling efficient heat transfer and unimpeded torque measurement. Unlike competitive designs, the heat transfer unit and the geometry heat spreader remain in constant spatial relation to one another regardless of the test gap, keeping heat transfer uniform at all times. Patented Active Temperature Control (ATC) eliminates the need for upper heater offset calibrations by providing actual measurement and control of the upper plate temperature. See ATC technology on page 15 for more details. A heated purge and cover create an oxygen-free environment around the sample to inhibit sample degradation.



Features and Benefits

- Smart Swap™ technology
- ATC with patented Non-Contact Upper Temperature Sensor
- Patented Smart Swap™ geometries
- Maximum temperature of 400 °C
- Optional low temperature cooling to -70 °C
- Maximum heating rate of up to 30 °C/min
- Controllable heating rates of 10 °C/min
- Environmental cover and heated purge gas
- Modeled for optimum heat transfer with minimum sample thermal equilibration time
- Heat transfer to sample independent of gap setting
- Sample trimming and plate removal tools
- Disposable Plate System
- Optional glass cover for sample viewing and for use with camera
- Ideal for QC testing or R&D
- Upper heater compatible with all Peltier Plate systems and UV curing accessories

Controlling Polymer Degradation During Testing

Viscoelastic properties of polymer melts can be affected by thermal and oxidative degradation at elevated temperatures. It is important to measure rheological properties in the absence of degradation, as well as evaluating the effectiveness of stabilizing additives such as antioxidants. This figure shows how effectively the EHP controls the environment for commercial polystyrene melt during a 10-hour time sweep experiment at 200 °C. The storage modulus, G' , can be seen to be very stable during the early stages of the test when the sample is purged with nitrogen. The data demonstrate the environment in the EHP is virtually oxygen-free. After about 4 hours, the inert gas is shut off and the effect of presence of oxygen on the viscoelastic response is seen immediately. The polystyrene degrades as evidenced by the sharp decrease in G' .

Controlling Polymer Degradation During Testing

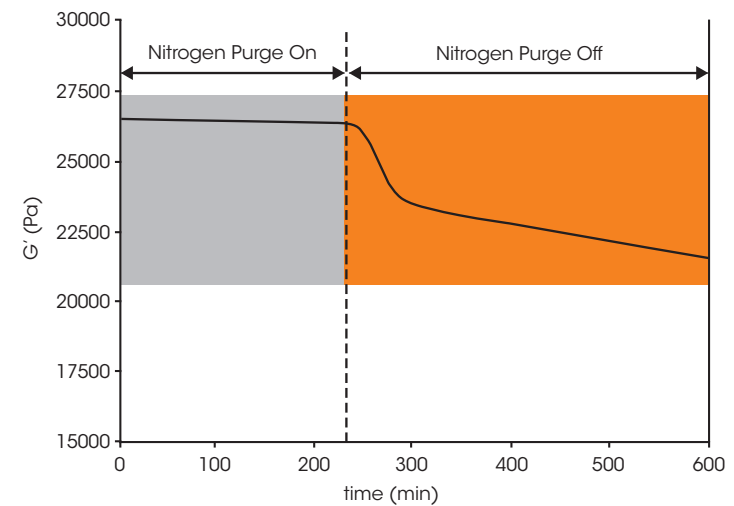

ETC OVEN | ENVIRONMENTAL TEST CHAMBER

Environmental Test Chamber (ETC)

The ETC is a high temperature Smart Swap™ accessory that employs a combination of radiant and convective heating and has a temperature range of -160 °C to 600 °C with heating rates up to 60 °C/min. This hybrid temperature control design provides fast response and temperature stability over a continuous range of 760 °C. The ETC is a very popular option for polymer applications and can be used with parallel plate, cone and plate, disposable plate, rectangular torsion and DMA clamps for solids, and the EVA & SER-3 accessories for extensional viscosity measurements. Typical materials that can be tested include thermoplastics, thermosets, elastomers, caulks and adhesives, solid polymers, asphalt binder, and oils and greases.



ETC Technology

The Smart Swap™ ETC is a “clam-shell” design. Each half of the oven contains an electric radiant heating element surrounded by a ceramic insulation block. Air or nitrogen gas is introduced through a purge ring with the gas flow directed over the heated coils, providing heat transfer by convection. For sub-ambient testing, both gas and liquid nitrogen are fed through the purge ring. Liquid nitrogen usage is kept to a minimum by switching from gas to liquid nitrogen only when cooling is required. Temperature sensors are used both in the oven and below the lower plates for temperature measurement and control. The ETC also features a camera viewer option installed through the chamber’s right-side ceramic block. The camera option features multiple light sources, remote focusing, and can be used over the entire temperature range. Used in conjunction with the streaming video and image capture software, real-time images can be displayed in the software and an image is stored with each data point for subsequent viewing. The ETC camera viewer is an ideal tool for data validation.

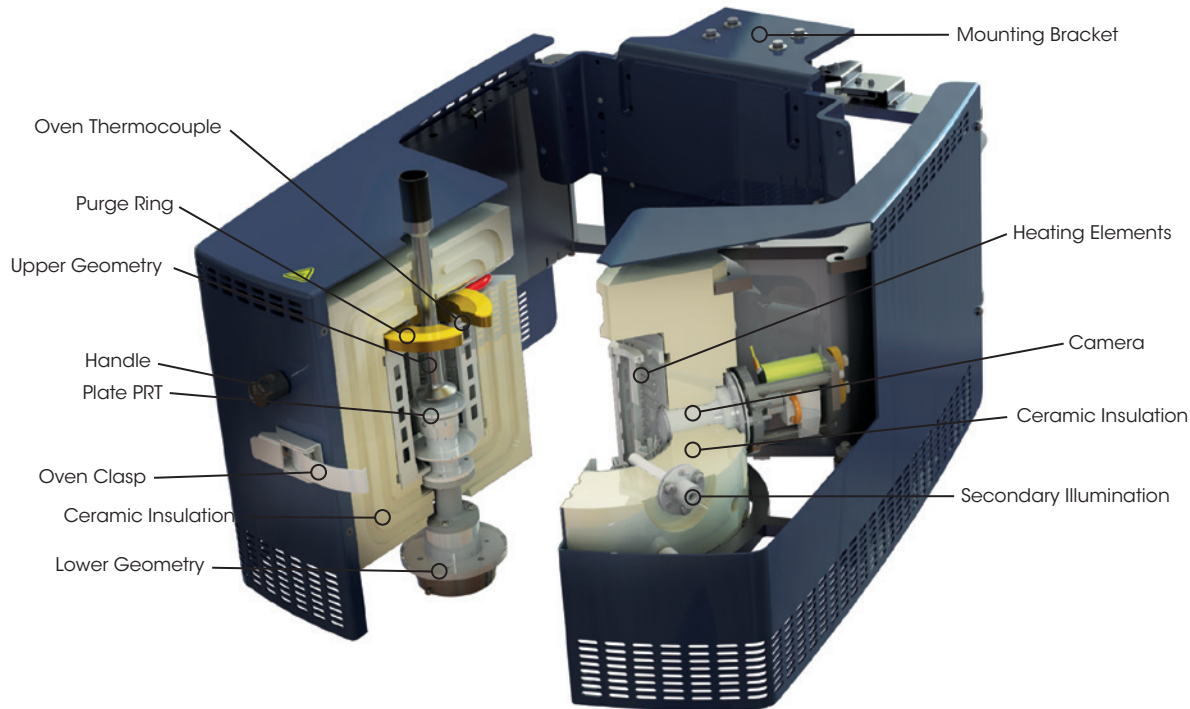

Features and Benefits

- Smart Swap™ technology for quick and easy installation in seconds
- Combined convection and radiant heating design
- Wide temperature range: -160 °C to 600 °C
- Maximum heating rate of 60 °C/min
- Liquid nitrogen option connects directly to bulk source
- Wide variety of stainless steel plates, cones, crosshatched, and disposable geometries
- Unique DMA geometries for testing solid samples in bending, tension, and compression
- Does not require additional electronic boxes
- Optional built-in camera viewer
- Melt rings for thermoplastic pellet samples
- Die punch for molded plaques
- Sample cleaning and trimming tools
- Extensional rheology measurements with Extensional Viscosity Accessory and SER3
- Universal Testing Platform

ETC Geometry Accessory Kits

Standard ETC Geometry kits, readily configured for testing specific materials, are available to accommodate the widest range of materials. This includes kits for testing thermoplastics and elastomers, thermosetting and other curing systems, pressure-sensitive adhesives, asphalt binder and solids. In addition, a wide variety of stainless steel geometries of various diameters and cone angles, and a choice of disposable plates are available to fully accessorize the temperature system. The kits feature patented Smart Swap™2 geometries that are automatically recognized and configured. Extensional viscosity measurements are enabled by the Extensional Viscosity Accessory (EVA) and the SER3 Universal Testing Platform. Additionally, a complete range of **Dynamic Mechanical Analysis (DMA) geometries are also available to test solid samples under controlled linear deformation** in bending, tension, and compression. See the DMA Accessory section for additional details.

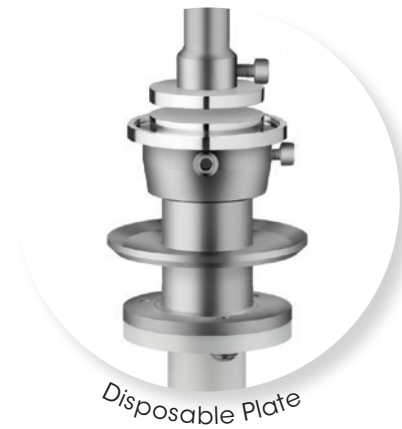

Air Chiller System (ACS)

The new Air Chiller System models offer unique gas flow cooling systems that provide the capability for sub-ambient testing without the use of liquid nitrogen. Available in two models, the ACS-2 and ACS-3, the chillers feature a multi-stage cascading compressor design that is capable of utilizing compressed air (7 bar, 200 slpm) as the cooling medium. The ACS-2 and ACS-3 models permit operation of the ETC at temperatures as low as -50 °C and -85 °C, respectively. The chiller systems can help eliminate or reduce liquid nitrogen usage and associated hazards from any laboratory and offer an incredible return on investment.

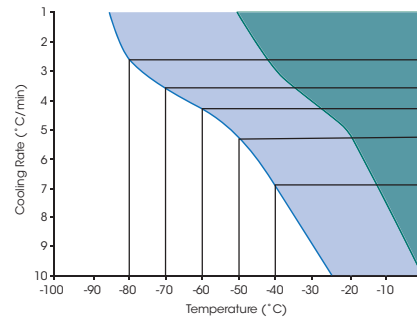

ABS/PC Blend Temperature Ramp

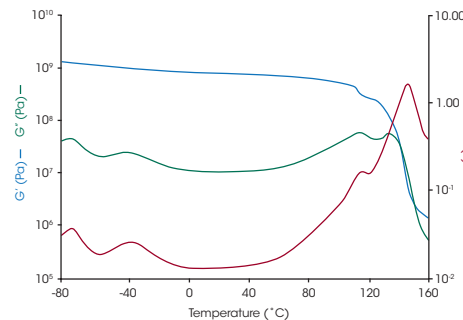

Features and Benefits

- **Safe:** eliminates the need for liquid nitrogen or other refrigerated gases
- **Convenient:** never change, refill, or order another tank of liquid nitrogen. The ACS is ready to run whenever you are.
- **Small:** occupies less space than equivalent liquid nitrogen cooling systems.
- **Affordable:** provides considerable cost savings over recurring gas deliveries.

Low Temperature Polymer Transitions

Polymers are often blended to produce a desirable combination of toughness, modulus, and processing characteristics. One such combination is a blend of polycarbonate (PC) with acrylonitrile butadiene styrene (ABS). The ACS-3 provides a sufficient range of temperature control to characterize the multiple low and high temperature transitions of this multi-component sample. The data in the figure were collected during a temperature ramp with a rectangular specimen in torsion.

DYNAMIC MECHANICAL ANALYSIS | ACCESSORY

Dynamic Mechanical Analysis (DMA)

Backed by over four decades of TA Instruments' expertise in rotational rheology and linear DMA measurements, the Discovery Hybrid Rheometer's DMA Mode adds a new dimension for testing solid and soft-solid materials. Now in addition to the most sensitive and accurate rotational shear measurements, the DHR can deliver accurate **linear Dynamic Mechanical Analysis (DMA) data**. Axial DMA complements solid torsion testing by providing a direct measure of the modulus of elasticity, or Young's Modulus (E). The new DMA mode is ideal for identifying a material's transition temperatures and provides reliable measurements over the instrument's full range of temperatures.

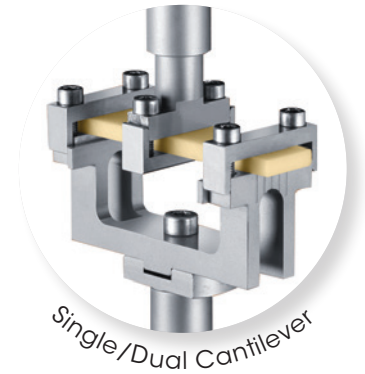
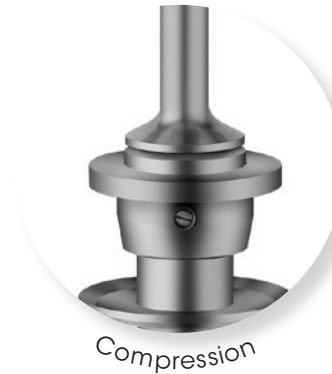
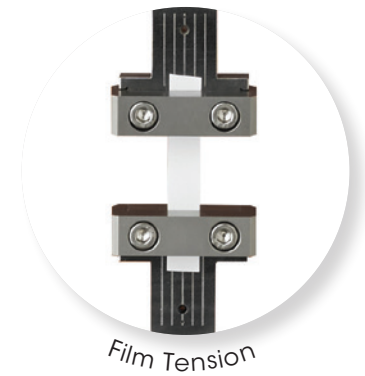
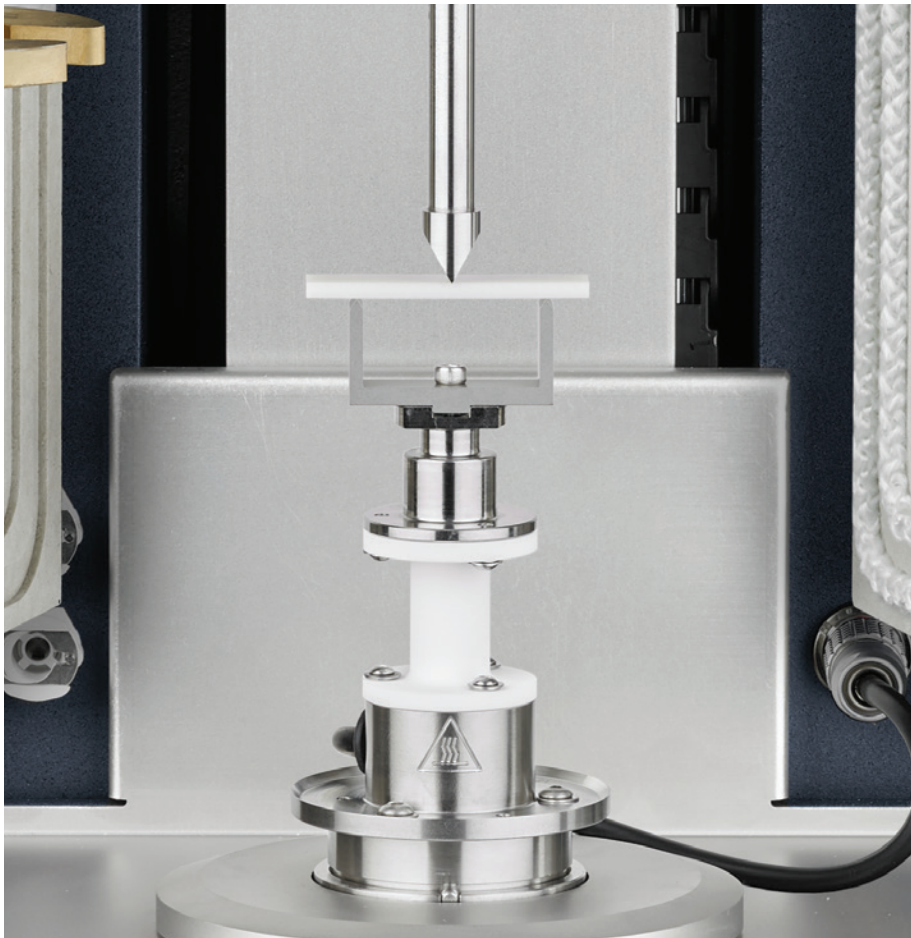

Technology

The axial DMA capability is enabled by the DHR's active Force Rebalance Transducer (FRT) and patented magnetic bearing technologies that permit amplitude-controlled oscillatory deformation in the axial direction. During DMA measurements, the position of the active bearing is directly controlled to impose oscillatory linear deformation on the sample. Competitive instruments employing air bearings and passive normal force measurements are inherently incapable of such measurements due to design limitations.

Switching between rotational and linear testing is effortless since the geometries employ Smart Swap™ for installation in seconds. Compatible with the ETC oven and Relative Humidity accessory, the DMA capability is available in film tension, three-point bend, single and dual cantilever, and compression. Powered by the **FRT technology**, the DMA mode does not require the installation of external components, so it is **always quick and easy to get great data!**

Specifications	
Minimum Force in Oscillation	0.003 N
Maximum Axial Force	50 N
Minimum Displacement in Oscillation	0.01 μm
Maximum Displacement in Oscillation	100 μm
Axial Frequency Range	6×10^{-5} rad/s to 100 rad/s (10 ⁻⁵ Hz to 16Hz)

Features and Benefits

- Force Rebalance Transducer Motor Control
- Smart Swap™ technology for quick installation
- Available on HR 30 and HR 20 models
- Complete array of geometries for axial testing:
 - 3-Point Bending
 - Film/Fiber Tension
 - Single and Dual Cantilever (Clamped Bending)
 - Parallel Plate Compression
- Axial Force Control tracks material stiffness and automatically adjusts static load
- Superior temperature control with the Environmental Test Chamber (ETC) up to 600 °C
- Liquid Nitrogen cooling to -160 °C
- Air Chiller Systems provide liquid nitrogen-free cooling to -85 °C
- Optional sample visualization with ETC camera
- Compatible with Relative Humidity accessory for complete environmental control of temperature and humidity

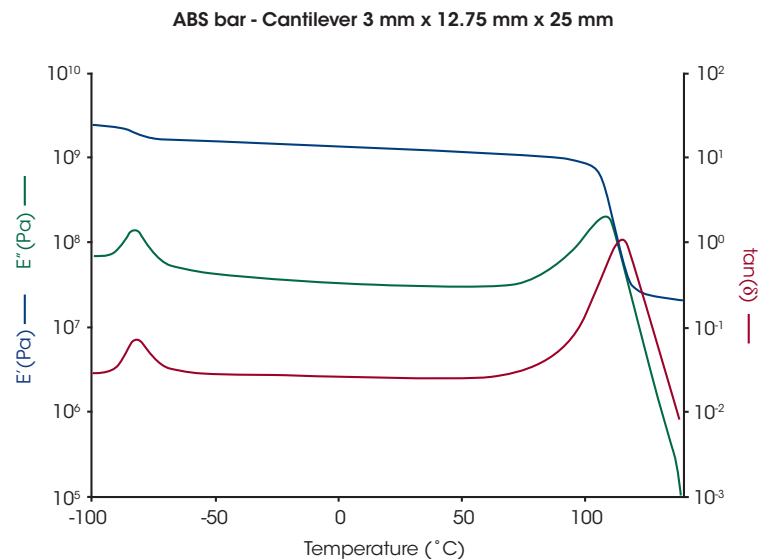

The figure above demonstrates the performance on the DMA mode during a temperature ramp run on an acrylonitrile butadiene styrene (ABS) sample in single cantilever over a temperature range of -100 °C to 140 °C. Two major transitions corresponding to the individual glass transitions of the butadiene (-82 °C) and styrene (115 °C) components are evident, indicating the incompatibility of the two monomers.

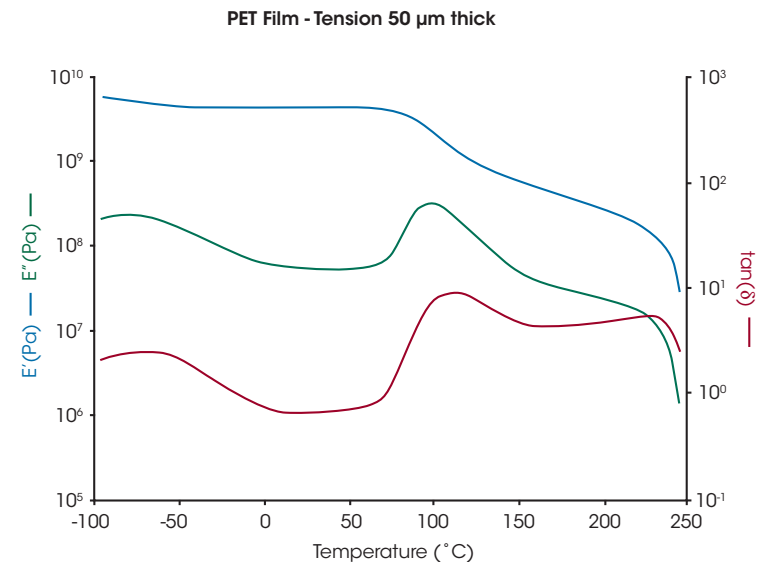

Axial DMA tests on thin films requires maintaining the axial force above the oscillation force to hold the sample in tension throughout the test. This capability is highlighted in the plot showing a temperature ramp on 50 μm thick PET film tested using tension geometry over a temperature range of -100 °C to 250 °C. Three major transitions are observed: a beta glass transition at -80°C, an alpha glass transition at about 111 °C, and melting at 236 °C. The data reveal a semi-crystalline structure with two amorphous relaxations and the DHR's force-tracking capabilities in such tests.

Thermoplastic Polymer Rheology Using Parallel Plate

Parallel Plate geometries are most popular for testing of thermoplastic polymer melts. An example of polystyrene characterized over a temperature range of 160 °C to 220 °C is shown in the figure to the right. Frequency sweeps were run at multiple temperatures over an experimental range of 0.06 to 628 rad/s. The magnitude of the viscoelastic properties, storage modulus (G') and loss modulus (G''), for the individual sweeps can be seen to decrease with increasing temperature over this frequency range. Since polymer melts are viscoelastic, their mechanical response will be time-dependent, so low frequency corresponds to long-time behavior. Time Temperature Superposition (TTS) is used to widen the range of data to higher and lower frequencies and generate a Master curve at a reference temperature pertinent to the application. The polymer's molecular structure dictates the magnitude and shape of the G' and G'' curves.

Polystyrene Frequency Sweeps from 160 °C to 220 °C

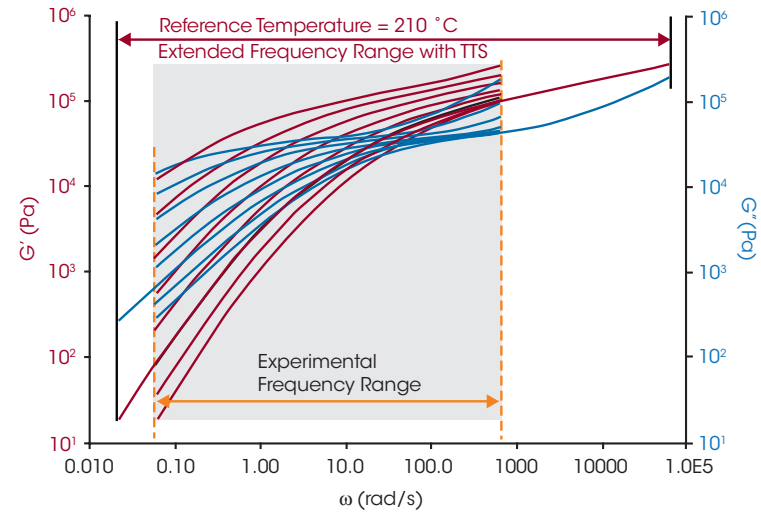

Thermoset Cure Using Disposable Plate Kit

Changes in the viscoelastic properties of reactive systems provide valuable information about their processing and end-use properties. Often these materials can start in the form of a low viscosity liquid, a paste, or even a powder, and after reacting end as a high modulus solid. If the material hardens and adheres to the testing surface, low-cost disposable parallel plates are required for testing.

The figure to the right shows the complex viscosity from a typical oscillatory temperature ramp and hold curing test conducted on a B-stage prepreg using 25 mm diameter disposable plates. The resin is impregnated on a woven glass matrix, which becomes part of the permanent high strength composite structure once the resin is cured. Upon heating, the resin softens until reaching a minimum viscosity, which is a very important processing parameter. If the viscosity is too high or too low, the resin will not flow or coat the matrix uniformly leaving voids, creating flaws in the composite. Eventually the viscosity starts building and the curing reaction takes off dramatically. The temperature is held constant at the processing temperature and the viscosity is monitored until the viscosity reaches a plateau indicating the completion of the reaction.

B-Stage Prepreg Temperature Ramp and Hold Cure

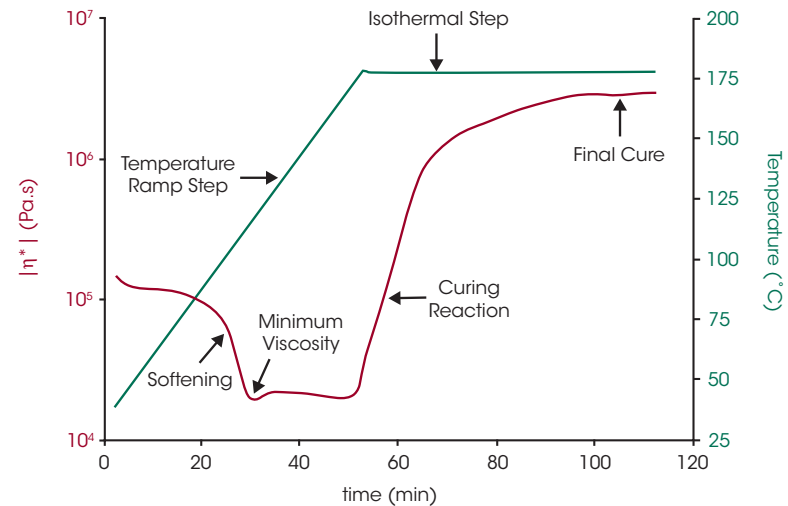

Solid Polymer Rheology Using Torsion Rectangular Clamps

The ETC oven has the ability to characterize the viscoelastic properties of rectangular solid samples up to 5 mm thick, 13 mm wide, and 50 mm long. The figure to the right shows an example of an oscillatory temperature scan on a solid ABS specimen run at 3 °C/min from -160 °C to 200 °C. The ABS is a copolymer that exhibits two glass transition temperatures: one at -81 °C associated with the Butadiene and one at 114 °C associated with Styrene. Transitions, or relaxations of molecular segments, are observed as step changes in the storage modulus (G') and as peaks in the loss modulus (G'') and damping ($\tan(\delta)$). The magnitude and shape of these parameters will depend on chemical composition as well as physical characteristics such as crystallinity, orientation, fillers, and degree of cross-linking.

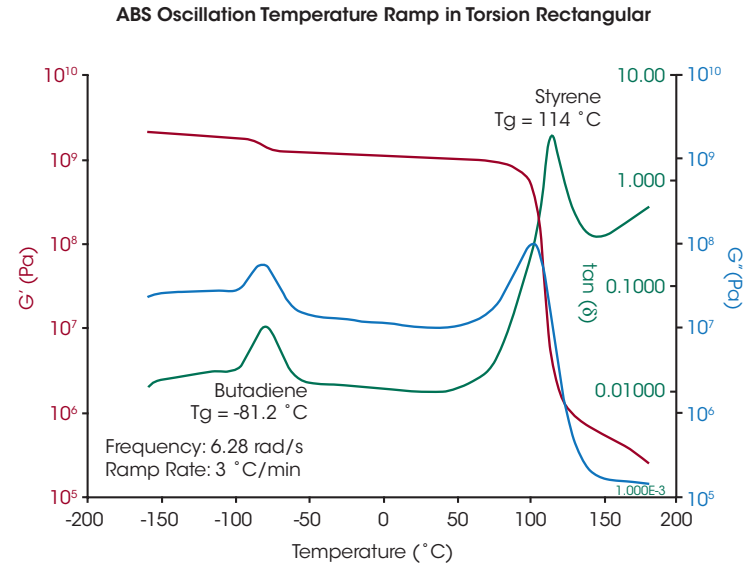

Extensional Viscosity measurements with the SER3 Attachment

The ETC is designed to accommodate the EVA (Extensional Viscosity Accessory) and SER3 (Sentmanat Extension Rheometer) for extensional viscosity measurements of materials like polymer melts. In the figure to the right, data are plotted for extensional viscosity measurements of standard LDPE 1810H at 150 °C at extensional rates from 0.02 to 3 s⁻¹ using the SER3. These results are compared to three times the corresponding low shear rate viscosity, which agrees well with the zero rate extensional viscosity prior to the onset of extensional thickening at different extension rates. In addition to extensional viscosity, the SER3 can also be used for solids tensile testing, tear testing, peel testing, as well as high-rate fracture testing.

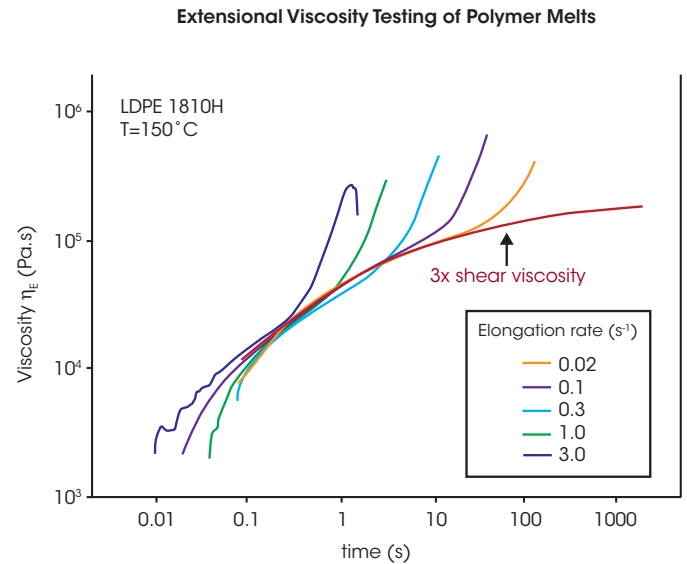

ORTHOGONAL SUPERPOSITION | ACCESSORY

Orthogonal Superposition (OSP)

Orthogonal Superposition (OSP) provides direct measurements of viscoelasticity under simultaneous shear, for complete characterization of materials throughout all stages of use. This new dimension in rheological testing bridges the gap between oscillation and flow, measuring a material's viscoelastic behavior under the same shear conditions experienced during critical processes such as mixing, extrusion, dispensing, pouring, pumping or spreading.

The rheology of complex fluids (emulsions, suspensions, gels, pastes and more) is traditionally characterized using either oscillation, or steady shear. Steady shear measures non-Newtonian viscosity over a range of shear rates or stresses, ensuring the sample will flow during processing, dispensing and end use. Oscillatory rheology provides a more information-rich measurement, characterizing the quiescent material's viscoelastic response, directly resulting from its microstructure.

With OSP, G' , G'' and Tan Delta are directly quantified under the same conditions relevant to performance in the field. Measurements of viscoelasticity during flow provide an inside look at shear-induced changes in microstructure, resulting in performance at key stages of use. OSP also offers 2D-SAOS (small amplitude oscillatory shear, in rotational and axial mode) for characterizing anisotropy, or particle orientation under shear. These testing capabilities deliver new insights into the relationship between structure and performance, providing a missing piece in characterizing complex rheological behavior



Features and Benefits

- Directly measure G' , G'' and Tan Delta through axial oscillation, precisely controlled by the DHR's patented magnetic bearing
- Measure changes in shear-sensitive microstructure of complex fluids with the enhanced force sensitivity of the SmartSwap™ OSP load cell
- Ensure accuracy in both rotational and axial measurements, avoiding artifacts from pumping effects and surface tension with the specially designed OSP double-gap cup and rotor
- Monitor temperature-dependent changes and replicate real-world processing conditions with optional temperature control through the Environmental Test Chamber (-10 °C to 150 °C)
- Experience intuitive, flexible OSP testing and analysis using powerful TRIOS software



ORTHOGONAL SUPERPOSITION | APPLICATIONS

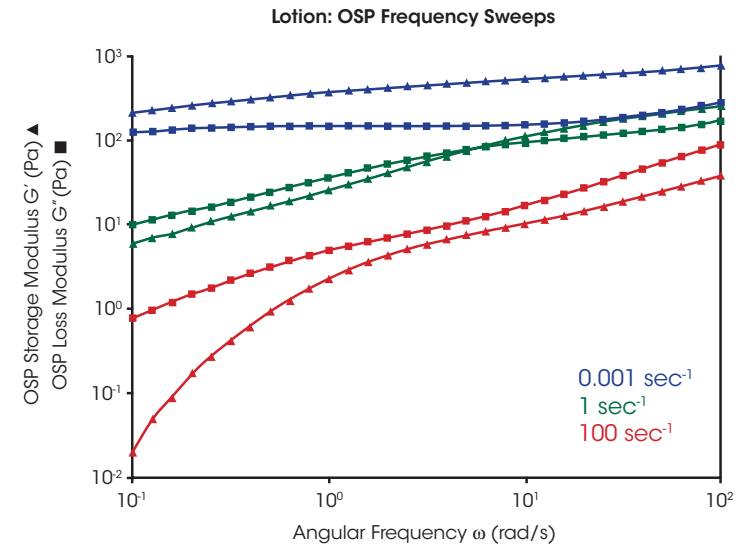
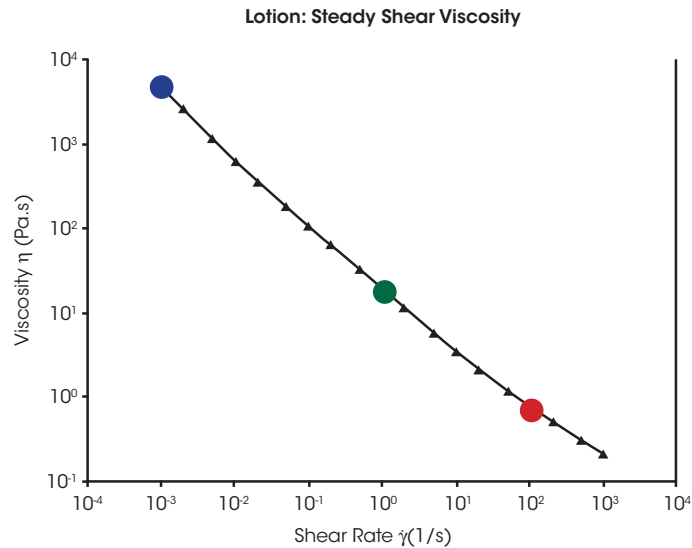

Like many personal care products, lotion exhibits a decrease in viscosity with increasing shear rate. This shear-thinning behavior is advantageous to performance at key stages of use:

- **At Rest:** High viscosity at low shear rates indicates emulsion stability and resistance to separation.
- **Dispensing:** A decrease in viscosity at medium shear rates enables the lotion to be easily dispensed from its packaging.
- **Spreading:** Under high shear rates, a low viscosity allows the consumer to easily apply a thin layer of lotion.

Steady-shear viscosity measurements are valuable, but lack insight into properties such as consistency and (texture/spreadability), vital to the consumer experience.

Specifications	
Oscillation Displacement	1 to 100 μm
Oscillation Force	0.001 to 5 N
Angular Frequency	0.001 to 100 rad/s
Temperature Range	-10 $^{\circ}\text{C}$ to 150 $^{\circ}\text{C}$

OSP frequency sweeps were performed on lotion, orthogonal to simultaneous shear. The viscoelasticity at each rate reflects shear-induced changes in microstructure and subsequent product performance:

- **At Rest:** The lotion behaves as a “soft solid”, where G' is greater than G'' , indicating it does not readily flow. This is beneficial for shelf stability, and easy handling by the consumer.
- **Dispensing:** At shear rates experienced during pumping or squeezing from a tube, the lotion shows a decrease in G' , indicating less elastic structure. At high frequencies, G' is greater than the viscous modulus, G'' , aiding in dispensing without drips.
- **Spreading:** Under higher shear, G' is greatly decreased and lower than G'' , especially at low frequencies. In this state, the lotion is easy to spread, and readily absorbed by the skin.

By directly measuring lotion’s viscoelasticity under critical shear rates, OSP measurements go beyond the traditional flow curve, characterizing the rheological behavior relevant to consumer perception.

POWDER RHEOLOGY | ACCESSORY

Powder Rheology Accessory

The Powder Rheology Accessory expands the DHR's capabilities to powders, enabling characterization of behaviors during storage, dispensing, processing and end use. Product development and process optimization are accelerated with quantitative measurements of dynamic flowability and shear properties of consolidated powder. Screening incoming raw materials or new formulations detects unexpected behavior to avoid future large-scale production issues and provide granular-level insights into powder morphology variations to enable solutions to challenging processing problems.

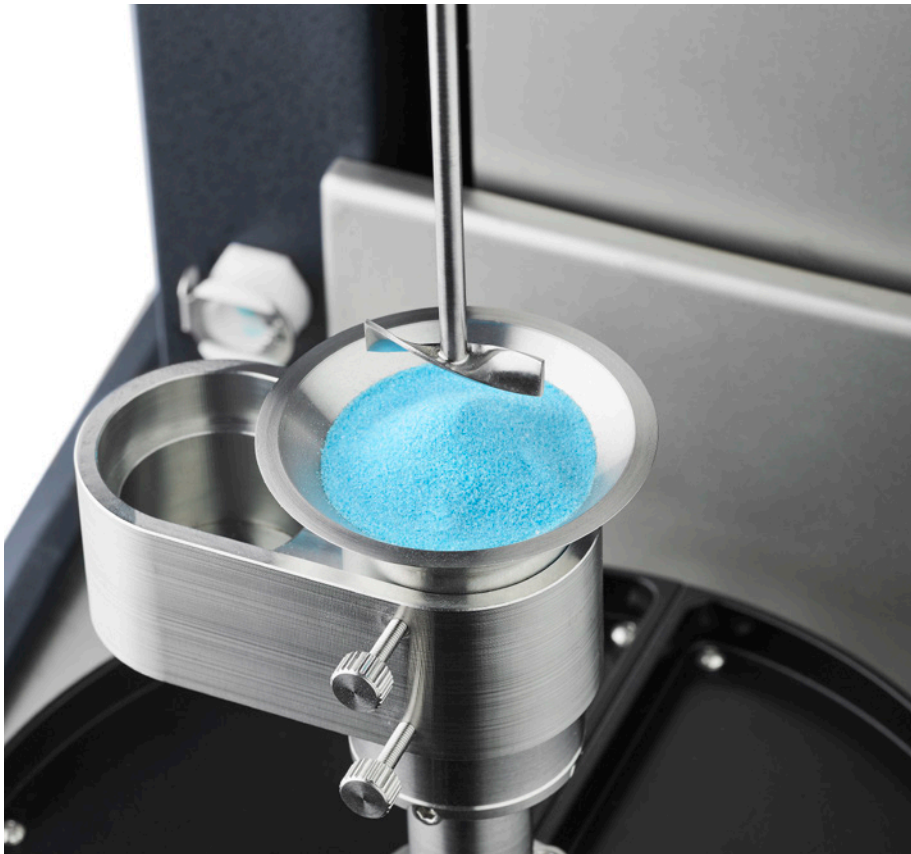

Shear Cell

Powder is consolidated in a serrated cup and plate and slowly sheared until yield under varying normal stress, reporting cohesion, yield strength, flow function and more.

Shear Cell Volume: 13.1 mL

ASTM D7891

Flow Cell

An impeller rotor is moved helically through the powder, measuring torque and force to report unconfined and confined Total Flowability Energy. **Flow Cell Volume: 21.2 mL**

Repeatable Sample Loading

Accurate results depend on repeatable powder sample preparation. The accessory's unique loading tools and automated conditioning procedures reduce sample-to-sample variability to as low as 0.2%.

Features and Benefits

- Flexibility to switch from liquid or solid samples to powders in less than 10 seconds, keeping pace with rapidly changing testing needs
- Measurements of powder behavior during processing, dispensing, storage and end-use with interchangeable tools for dynamic flowability and shear properties
- Repeatable results enabled by fast, easy intuitive sample loading and automated conditioning protocols
- Walk-up usability for every operator - TRIOS Powder test forms streamline routine test methods while enabling complete customizability
- Simplified data interpretation with optional Powder Analysis software, reporting quantitative key performance indicators in one click

POWDER RHEOLOGY | APPLICATIONS

Powder Rheology Applications

Powder materials present unique challenges at all stages, from new formulation development to final product performance. The Powder Rheology Accessory provides insights into real-world behavior to accelerate solutions to processing problems.

Formulation



In new product development, powder rheology measurements on small lab-scale samples demonstrate impacts of formulation changes on processability and performance, avoiding future large-scale problems.

Storage



Hopper and silo designs are optimized to ensure consistent dispensing and avoid blockages, rat-holing or avalanching, using quantitative Shear Cell measurements of consolidated powder.

Stability



Changes in powder morphology like caking, agglomeration or segregation may arise during processing or storage. Flow testing detects these instabilities, which compromise processability and product quality.

Processing



Screening powder for flowability energy across a wide range of conditions predicts behavior during processes such as feeding, mixing, granulation and mold-filling, ensuring successful processing.

End Use



Products like food and personal care must exhibit expected behavior during use. Measurements of powder characteristics impacting performance help ensure consumer acceptance.

Effects of Additives on Powder Shear Properties

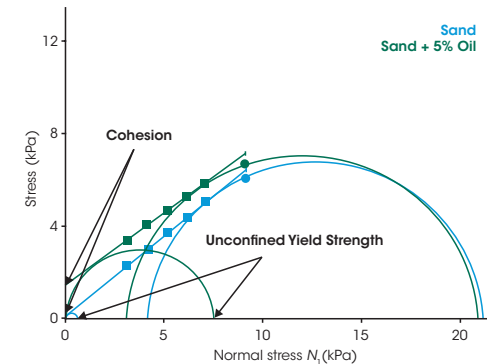

Bulk powder properties are impacted by any formulation changes. Powder Shear tests detect these changes, shown by measuring sand before and after blending with silicone oil at 5%. This small addition significantly changes behavior under low stress, increasing Cohesion and Unconfined Yield Strength by a factor of 10. The familiar effects of wetting sand to build a sandcastle are quantified by the Shear Cell, and broadly applicable to optimizing performance of any powder formulation.

Impacts of Morphology on Processability

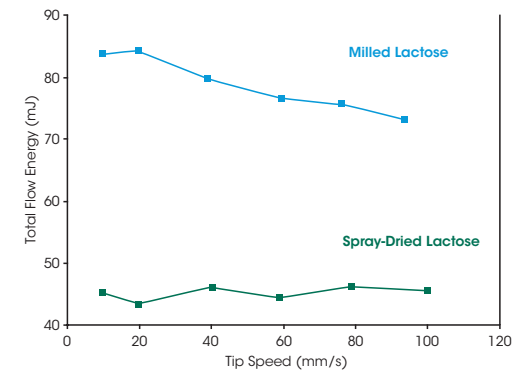

Lactose is widely used as a pharmaceutical excipient, but processability is highly dependent on particle morphology. Milled lactose's jagged, irregular particles tend to interlock and inhibit flow, unlike the smooth, spherical particles of spray-dried lactose. Flowability measurements reveal milled lactose's resistance to flow increases at low rates, predicting slow material transfer during dispensing or mold filling. This insight identifies spray-dried lactose as the ideal excipient to prevent costly manufacturing issues and ensure product quality.

MODULAR MICROSCOPE | ACCESSORY

Modular Microscope Accessory (MMA)

The Modular Microscope Accessory (MMA) enables complete flow visualization – including counter-rotation – with simultaneous rheological measurements on the Discovery Hybrid Rheometer. A high-resolution camera collects images at up to 90 fps coupled with industry-standard microscope objectives that provide magnification up to 100x. Illumination from a blue-light LED can be coupled with a cross-polarizer or dichroic splitter for selective illumination or fluorescence microscopy.

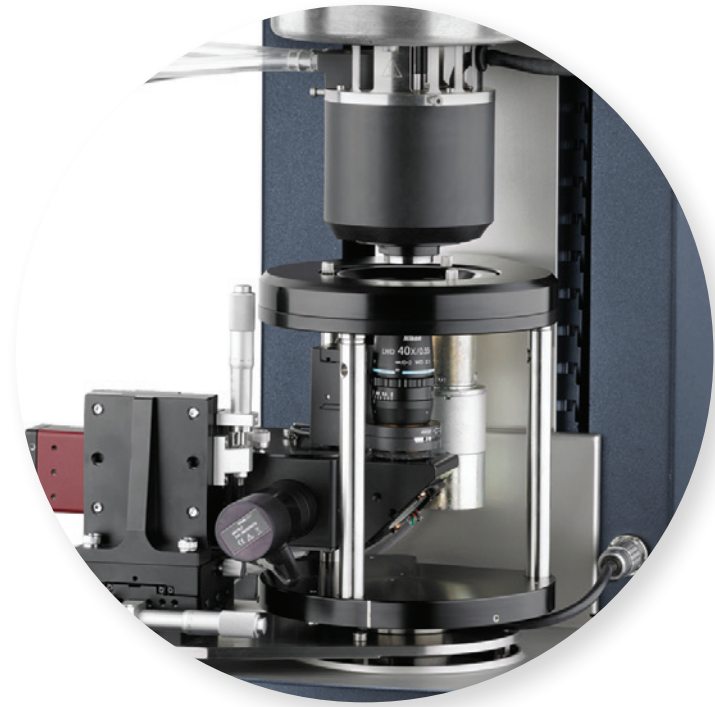
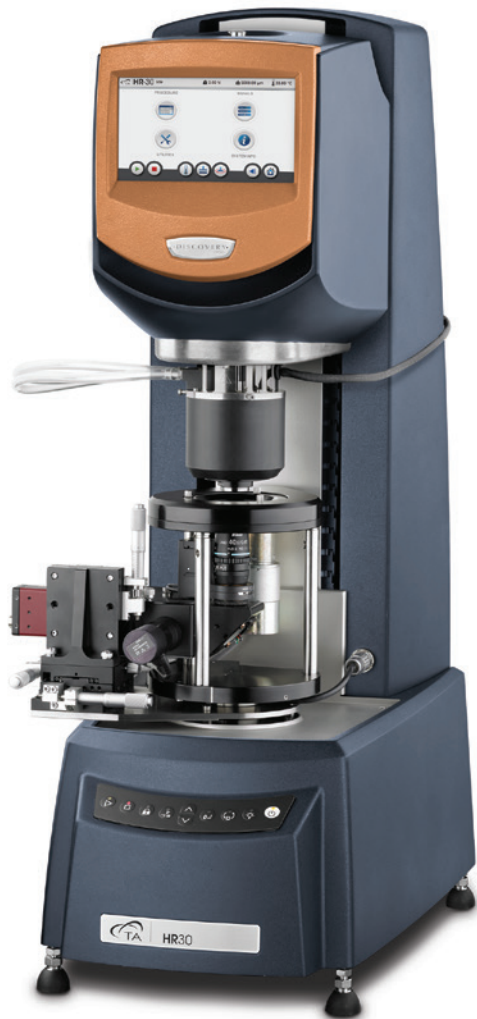

Technology

The MMA mounts directly to the Discovery Hybrid Rheometer and does not require any additional stands, lifts, or other support. This makes the system simple to install and effectively isolates it from external vibration and other sources of environmental interference that would compromise image quality.

A precision x-y-z micrometer positioning system allows the microscope's field of view to be placed anywhere within the sample. This allows for investigation of flow homogeneity anywhere from the axis of rotation to the sample edge. Precise depth-profiling is enabled by an optional Piezo scanning system. This precision mechanism permits the depth of the focal plane to be adjusted in software-controlled increments over a 100 μm range for quantitative depth-profiling with steps as small as 0.1 μm .

The MMA is compatible with the Upper Peltier Plate (UPP) for temperature control from -20 °C to 100 °C.

Counter-rotation: Stagnation Plane Microscopy

When visualizing materials under flow at high shear rates, features of interest can rapidly move across the field of view, imposing limits on the time available to observe shear-induced changes in the sample. An optional counter-rotation stage available for the MMA rotates the lower glass plate at a constant velocity in a direction opposite to that of the upper plate - this creates a zero-velocity stagnation plane where the fluid is stationary with respect to the camera, allowing a fixed field of view throughout the experiment. The location of this zero-velocity plane within the gap can be controlled by varying the ratio of the upper and lower plate velocities without changing the effective shear rate across the sample. This counter-rotation system is a Smart Swap™ accessory that can be added at any time.

Cross-Polarizer	Included
Fluorescence Dichroic Splitter	Optional
Counter-Rotation	Optional Smart Swap™ system
Piezo Scanning Mechanism	Optional, 100 µm travel
Video and Image Capture	Software-controlled, data file integrated
Field of View	320 µm x 240 µm at 20x
Illumination	Blue-light LED
Image Capture	640 x 480 pixels, 90fps
Temperature Range (with UPP)	-20 °C to 100 °C
Geometries	Plates and Cones up to 40 mm diameter

Features and Benefits

- Smart Swap™ technology for quick installation
- Available counter-rotation for stagnation plane imaging on any Discovery Hybrid Rheometer
- High resolution, high frame-rate image collection
- Effective temperature control through Upper Peltier Plate (UPP)
- Direct sample temperature measurement with Active Temperature Control
- Visual access to any position within the measurement area, e.g. center, edge, or mid-radius
- Brightfield and cross-polarization modes included, optional fluorescence and precision depth-profiling
- Wide selection of commercially-available objectives

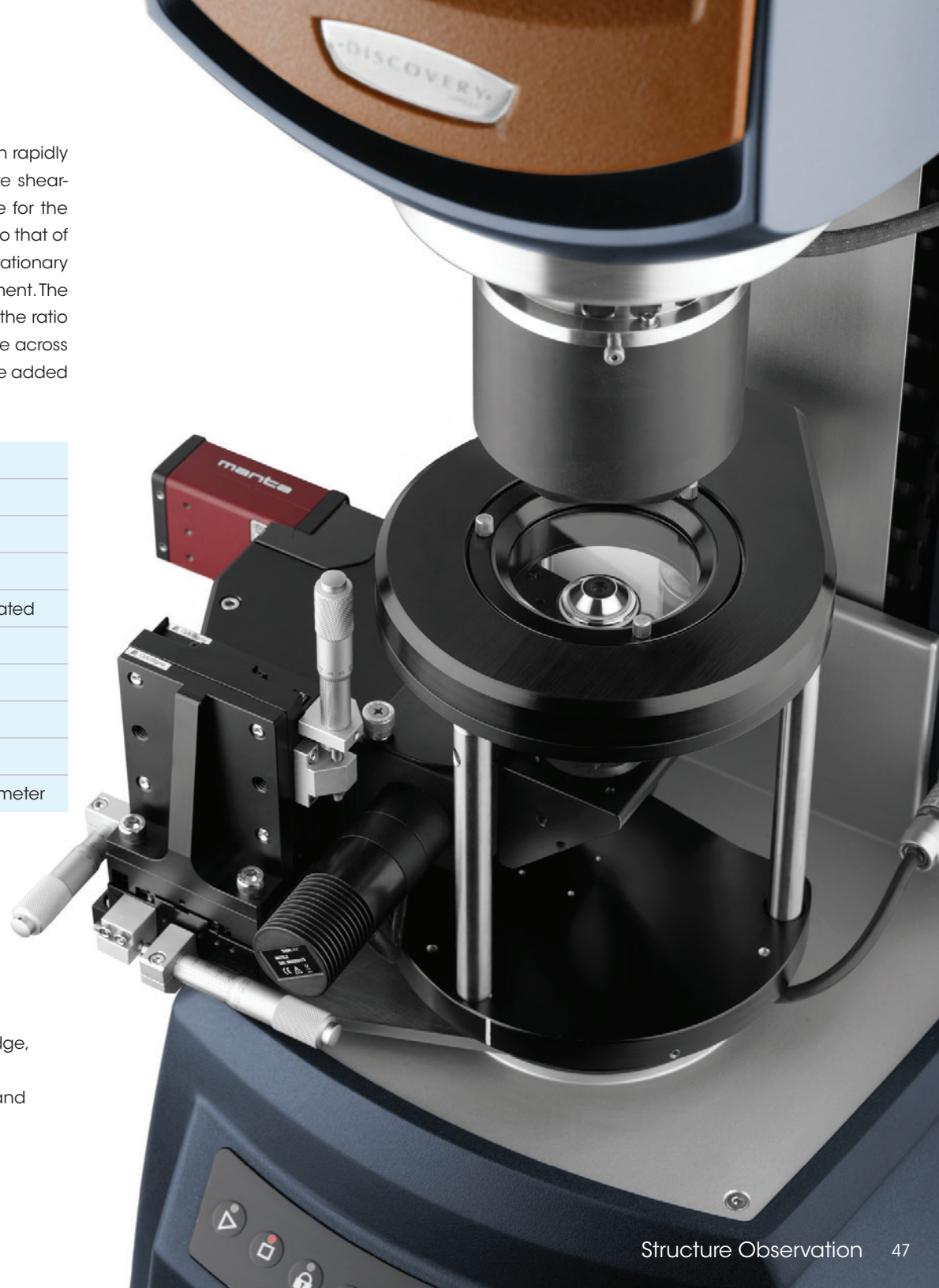

OPTICS PLATE | ACCESSORY

Optics Plate Accessory (OPA)

The OPA is an open optical system that permits basic visualization of sample structure during rheological experiments, revealing important insights about material behavior under flow. An open platform with a borosilicate glass plate provides a transparent optical path through which the sample can be viewed directly. This enhances the understanding of a range of materials, especially suspensions and emulsions. The accessory is easy to use and install, accommodates diverse optical systems, and offers accurate temperature control over a wide range for flow visualization and microscopy.



Features and Benefits

- Smart Swap™ technology for quick installation
- Simultaneous rheological measurements and direct visualization
- Visual access to any position within the measurement area, e.g. center, mid-radius, or edge
- Upper Peltier Plate (UPP) with patented Active Temperature Control for precise temperature measurement

Technology

The OPA mounts to the DHR Smart Swap™ base and may be coupled with the Upper Peltier Plate (UPP) with Active Temperature Control for accurate, direct sample temperature measurement and control from -20 °C to 100 °C. The OPA can be used with cone or parallel plate geometries up to 60 mm in diameter.

The OPA is available in any of the following configurations:

- Open Plate: An open system that facilitates customization including a set of 8 M2 tapped holes for the easy adaptation of any optical system
- OPA with Modular Microscope Accessory (MMA): A static optical stage for microscopy.
- OPA with Digital Microscope: A high resolution digital camera permits the capture of still images or video. The camera is mounted on a y-z positioning stage to adjust focus and the field of view. Sample illumination is provided by the microscope's 8 white LEDs.

OPA with Digital Microscope	50x	240x
Working Distance	11.4 mm	11.6 mm
Field of View	7.8 mm x 6.3 mm	1.6 mm x 1.3 mm
Illumination	8 white LED's	
Image Capture	1280 x 1025 pixels, 30 fps	
Temperature Range (with UPP)	-20 °C to 100 °C	
Geometries	Plates and Cones up to 60mm diameter	

OPA with Digital Microscope

The images below show the structure of a PDMS-PIB emulsion at rest and after shear flow. At rest, the emulsion structure consists of spherical droplets with a polydisperse size distribution. After shearing at 10 s^{-1} for 10 minutes, there is a decrease in the number of larger droplets and a shift towards more uniform droplet sizes.

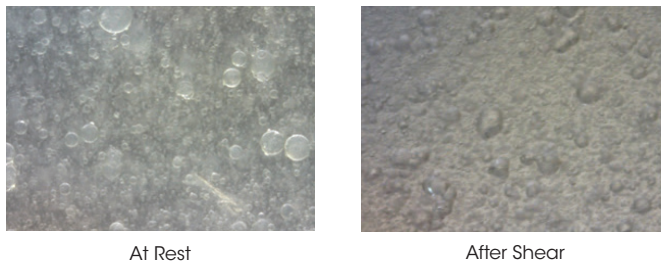

MMA: Cross-Polarization Microscopy

The figures to the right shows an example of cross-polarization microscopy data collected using the Modular Microscope Accessory. A light crude oil sample was cooled from $25 \text{ }^{\circ}\text{C}$ to $0 \text{ }^{\circ}\text{C}$ at a controlled rate of $1 \text{ }^{\circ}\text{C}/\text{min}$ during a small amplitude oscillatory test. The images show cross-polarization micrographs of the sample at various stages during the experiment.

At $20 \text{ }^{\circ}\text{C}$, the sample is a homogeneous, low viscosity liquid with no crystalline features. As the sample is cooled, the viscosity rises sharply beginning at $15 \text{ }^{\circ}\text{C}$. This process, known as outwaxing, is caused by the crystallization of long-chain hydrocarbons and paraffinic wax components in the sample and is accompanied by the appearance of several crystalline elements in the micrograph image. With additional cooling, the sample viscosity continues to increase, concurrent with an increase in the number and size of crystalline domains. Simultaneous imaging confirms that the cause of the observed viscosity increase is the onset of crystallization. The results highlight the use of microscopy as a powerful tool to investigate and understand the relationship between sample structure and its material properties.

MMA: Brightfield & Fluorescence Microscopy

The micrographs below demonstrate the imaging capability of the MMA in brightfield and fluorescence microscopy modes. The images show glass spheres suspended in polydimethylsiloxane (PDMS) in brightfield imaging, and fluorescently dyed polystyrene spheres dispersed in a commercial hair gel sample imaged using the dichroic splitter for fluorescence microscopy. A $20\times$ objective was used to image both samples, scale bar = $50 \mu\text{m}$

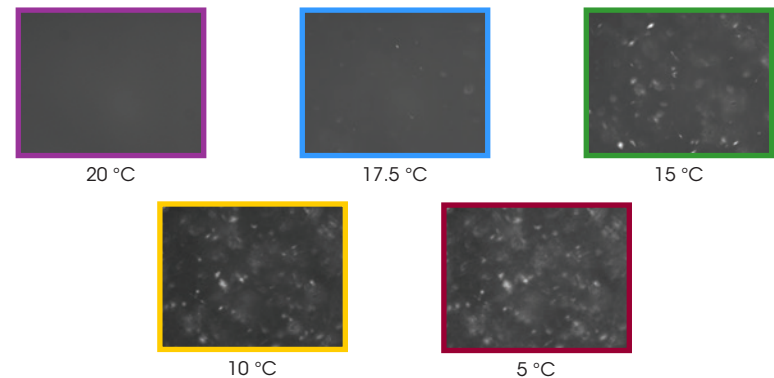
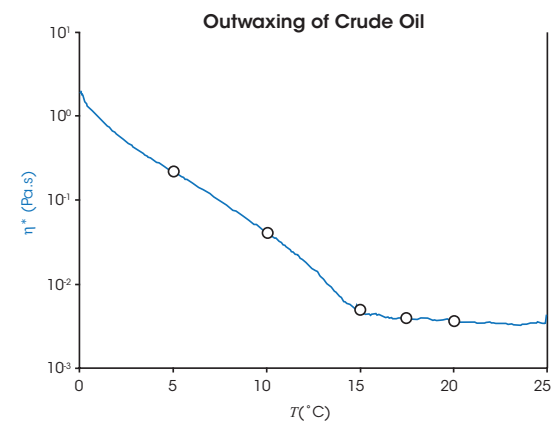
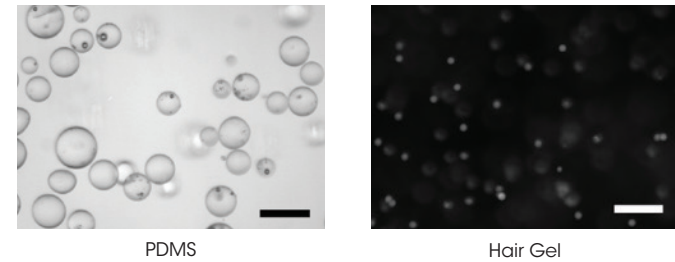

SMALL ANGLE LIGHT SCATTERING | ACCESSORY

Small Angle Light Scattering (SALS)

The Small Angle Light Scattering (SALS) System is an option for simultaneously obtaining rheological and structural information, such as particle size, shape, orientation and spatial distribution. It is available for the HR-20 and HR-30 rheometers. The option incorporates TA Instruments' Smart Swap™ technology, bringing a new level of speed and simplicity for making simultaneous rheology and SALS measurements. The system can be installed, aligned, and ready for measurements in as little as five minutes. It features patented Peltier Plate temperature control(1) and the scattering angle (θ) range over which measurements can be made is $\sim 6^\circ$ to 26.8° . The scattering vector range (q) is $1.38 \mu\text{m}^{-1}$ to $6.11 \mu\text{m}^{-1}$ and the length scale range is about $1.0 \mu\text{m}$ to $\sim 4.6 \mu\text{m}$.

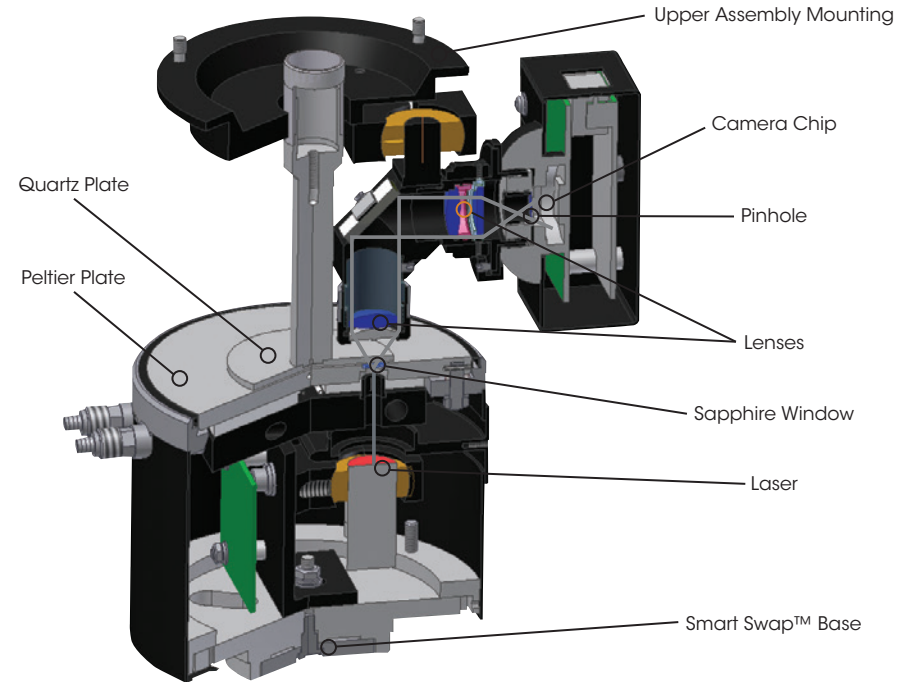

Technology

The SALS accessory consists of upper and lower assemblies and quartz plate geometry. The lower assembly includes an integrated Class 2 laser (with 0.95 mW diode and wavelength $\lambda = 635 \text{ nm}$) situated below a patented(1) Peltier Plate with a 5 mm diameter quartz window. The Peltier Plate surface is stainless steel with a temperature range of 5°C to 95°C . The upper assembly consists of a set of lenses and a camera. The scattered light is focused through a lens pair mounted within a height-adjustable cap to focus at varying sample depths. The light is then focused through a second lens and sent through an adjustable polarizer for both polarized and depolarized measurements. Finally, the scattering is collected through a pinhole and recorded by the camera. The upper geometry is a 50 mm diameter, 2 mm thick optical quartz disk. To comply with the singlepoint correction for the parallel plates, the laser is set at 0.76 times the plate radius which is 19 mm from the axis of rotation of the plate. This arrangement keeps the SALS system compact, while allowing for quick and reproducible positioning and focusing. A set of neutral density filters is available as an option to reduce laser intensity.

(1) U.S. Patent # 7,500,385

Features and Benefits

- Smart Swap™ technology
- q vector range $\sim 1.38 \mu\text{m}^{-1}$ to $6.11 \mu\text{m}^{-1}$
- Objects length scale range $\sim 1 \mu\text{m}$ to $4.6 \mu\text{m}$
- Scattering angle $\sim 6^\circ$ to 26.8°
- Wavelength 635 nm
- Compact upper assembly requiring minimal adjustment
- Smart Swap™ lower assembly with factory aligned laser
- Class 2 laser - No safety issues
- Adjustable laser intensity with optional neutral density filters
- Variable depth focus to adjust for different geometry gaps
- Adjustable polarizer for scattering in parallel or perpendicular to the incident light
- Image focused directly onto camera chip – Does not require screen or darkened room
- Quantitative measurements possible by calibration with monodisperse Polystyrene beads.
- Patented Peltier Plate temperature control

Shear-Induced Phase Separation of Micellar Solutions

Self-assembled surfactant micelles show a variety of shear-induced microstructural transformations that are important for material formulation and function for a wide array of applications. Simultaneous measurements of rheology and surfactant microstructure, using SALS under shear, provides a valuable tool in examining shear-induced transitions in such fluids. The data in the figure show scattering images captured synchronously with rheometry data on a surfactant system. At low shear rates below the stress plateau, no measurable scattering is obtained from the sample, suggesting no large-scale structuring of the fluid. However, in the stress plateau, a strong anisotropic scattering pattern develops with increasing shear rate. This “butterfly” pattern results from phase separation, where the interface between the two phases generates a strong scattering contrast.

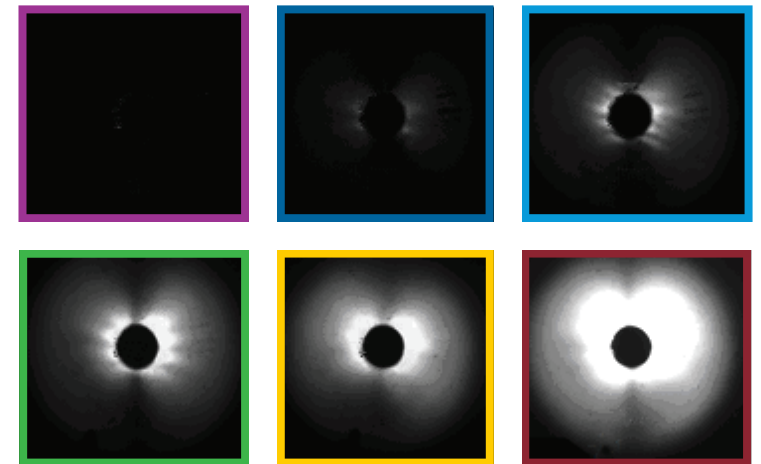
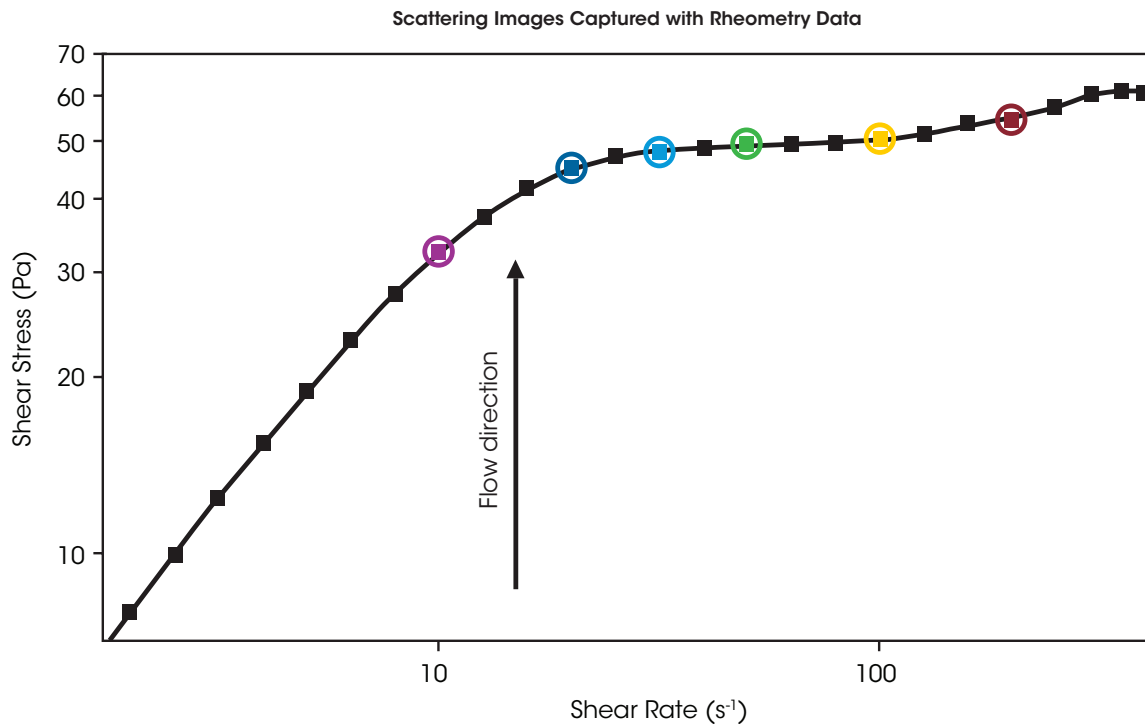

INTERFACIAL RHEOLOGY | ACCESSORIES

Interfacial Accessories

Rheometers are typically used for measuring bulk or three-dimensional properties of materials. In many materials, such as pharmaceuticals, foods, personal care products and coatings, there is a two-dimensional liquid/liquid or gas/liquid interface with distinct rheological properties. Only TA Instruments offers a choice of different devices for the most flexibility and widest range of quantitative interfacial rheology measurements. The options include a patented Double Wall Ring (DWR) system for quantitative viscosity and viscoelastic information over the widest measurement ranges, a Double Wall Du Noüy Ring (DDR) for samples available in limited volumes, and a traditional Bicone for interfacial viscosity measurements. The new **Interfacial Exchange Cell** accessory further expands the capabilities of the DWR geometry through a controlled exchange of the sub-phase composition during interfacial measurements.

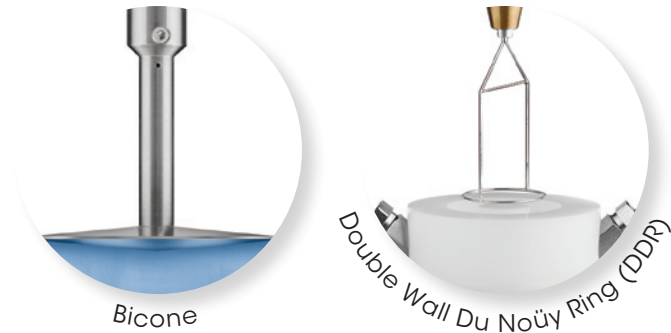
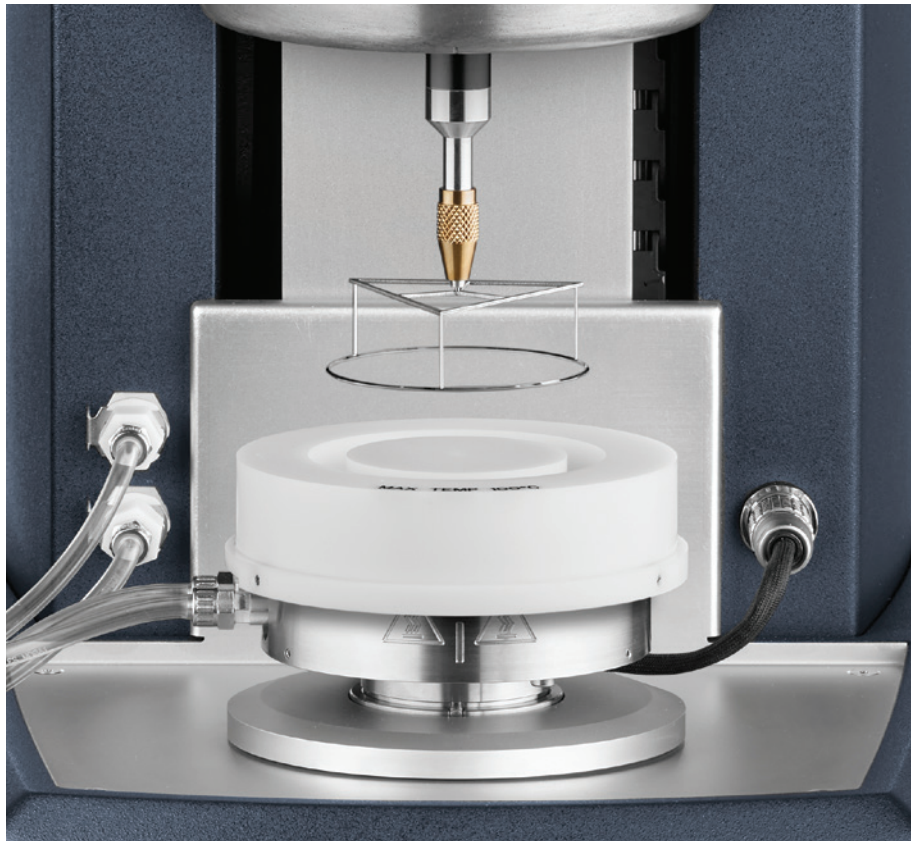

Surfactant Concentration & Interfacial Viscosity

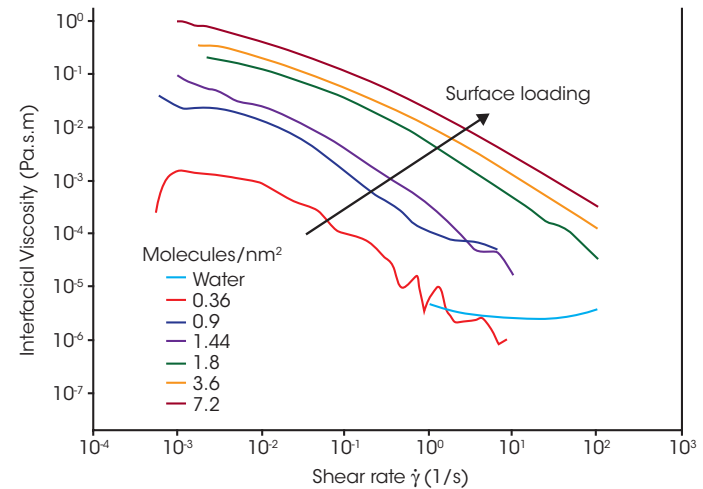

Shear Thinning Behavior in Interfacial Rheology

In this series of tests, the surfactant SPAN65 was spread evenly at the water-air interface using a solution of SPAN 65 in chloroform. After the evaporation of the chloroform, the SPAN65 film deposited on the water was measured using the Double Wall Ring Interfacial accessory. Different loadings of surfactant were tested from 0 (just water, no surfactant layer) to 7.2 molecules per nm². Continuous shear experiments were conducted and the interfacial viscosity was measured as a function of shear rate and interfacial concentration. As expected, the surfactant layer shows significant shear thinning. At high rates, sub-phase contributions dominate for loadings less than 1.8 molecules/nm². Sub-phase correction becomes important below an interfacial viscosity of 10⁻⁵ Pa.s.m and the well-defined geometry of the DWR makes these quantitative sub-phase corrections possible. At higher interfacial viscosities, sub-phase contributions are negligible and the correction is unnecessary.

Interfacial Geometries

TA Instruments offers patented double wall interfacial rheology geometries that provide well-defined shear planes on both sides of the geometry for quantitative flow fields and high sensitivity to surface rheology. In TA Instruments interfacial rheology systems, the sample is contained in a Delrin® trough with measuring geometries made of Platinum-Iridium for the Double Wall Ring (DWR) and Double Wall Du Noüy Ring (DDR) geometries. These materials are selected for their inert chemistry and ease of cleaning. The choice of different interfacial rheology options gives you the greatest flexibility in choosing the appropriate geometry for your application.

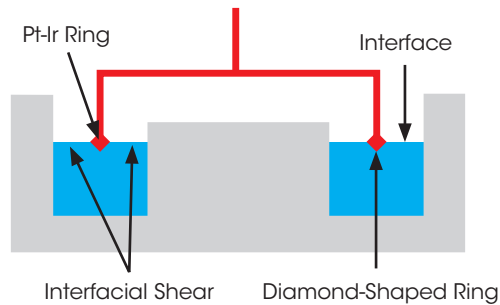

Double Wall Ring

The Double Wall Ring (DWR) is the most sensitive interfacial rheology geometry and is capable of truly measuring quantitative viscoelastic parameters. This patented ultra-low inertia ring⁽¹⁾ features a diamond shaped cross-section to “pin” the interface to the ring. Together, the large diameter and narrow cross-section minimize subphase drag. The low inertia design assures the best oscillation measurements over the widest frequency range of any interfacial system. As a result, surface viscosity measurements as low as 10^{-5} Pa.s.m are possible without complicated corrections. Unlike competitive offerings, the DWR does not require additional experiments or mathematical manipulation to account for the torque contributions from the individual phases of the interfacial system.

(1) U.S. Patent # 7,926,326

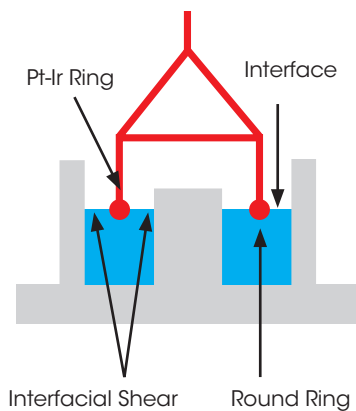

Du Noüy Ring

The Du Noüy ring geometry of the Double Wall Du Noüy Ring (DDR) is an industry standard device used for surface tension measurements. The round cross-section allows for meniscus formation between the interface and geometry, creating a slight error in the absolute data. With a much smaller diameter of 20 mm, this system is ideal for testing interfacial properties of samples that are available in very limited quantities, such as biological or pharmaceutical materials. The patented double wall trough ⁽¹⁾ provides well-defined interfacial shear planes on both sides of the geometry surface, permitting the characterization of viscoelastic interfaces in both steady shear and oscillatory tests.

(1) U.S. Patent # 7,926,326

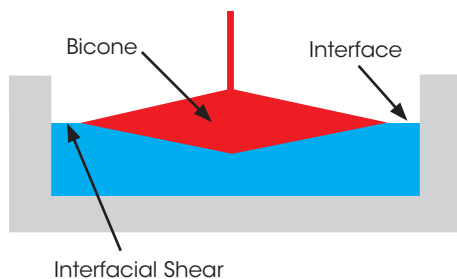

Bicone

The Bicone is a double conical stainless steel geometry with a sharp edge that reproducibly pins the interface. Rheological tests with the bicone require mathematical corrections to account for the drag contributions from the cone surface submerged in the subphase. The geometry's large moment of inertia limits measurement capability to interfacial viscosity in steady shear mode, precluding valuable measurements of quiescent structure and elasticity. Well-established in scientific literature, the bicone is appropriate for studying stiff interfaces in steady shear

INTERFACIAL EXCHANGE CELL | ACCESSORIES

Interfacial Exchange Cell

The Interfacial Exchange Cell expands TA Instruments' patented offerings for interfacial rheology by providing the ability to directly manipulate the composition of the lower liquid layer (subphase) during rheological measurements. This unique capability enables the characterization of the interfacial response to a modified subphase composition, opening possibilities for quantifying the effects of changes in pH, salt, or drug concentration, or the introduction of new proteins, surfactants, or other active ingredients.

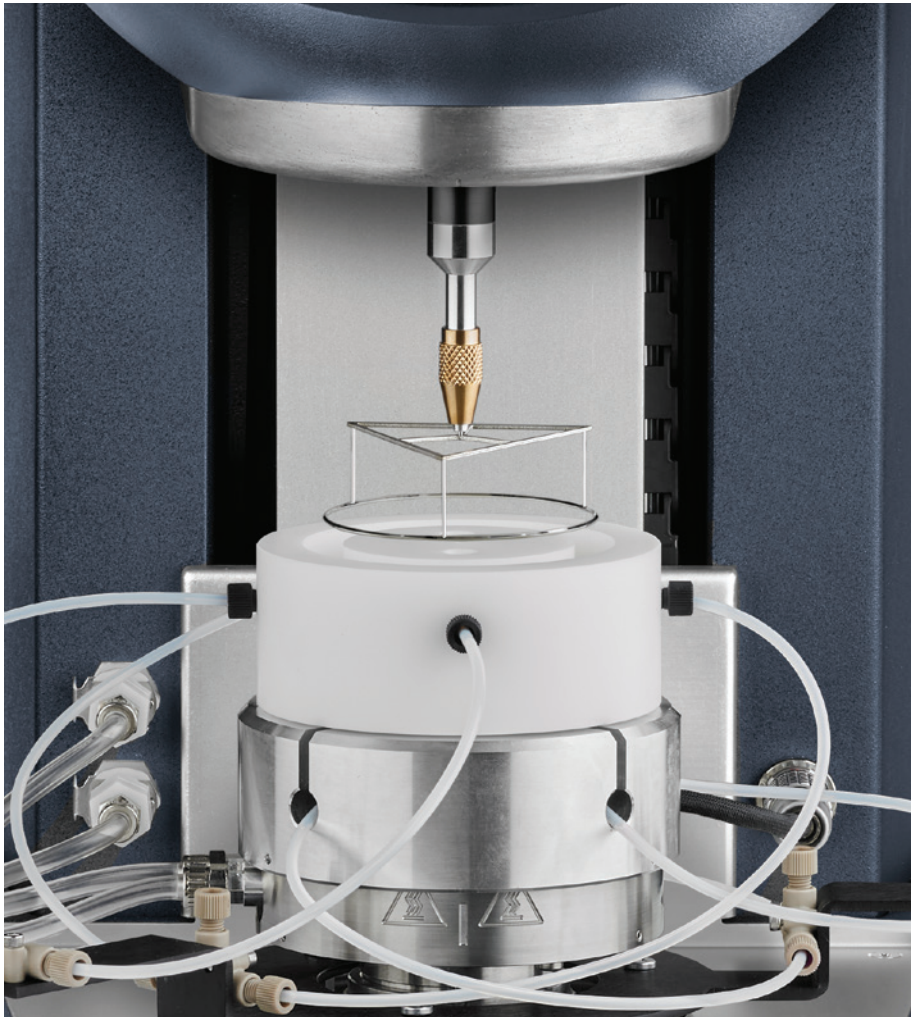

Effect of surfactant addition to a stable protein interface

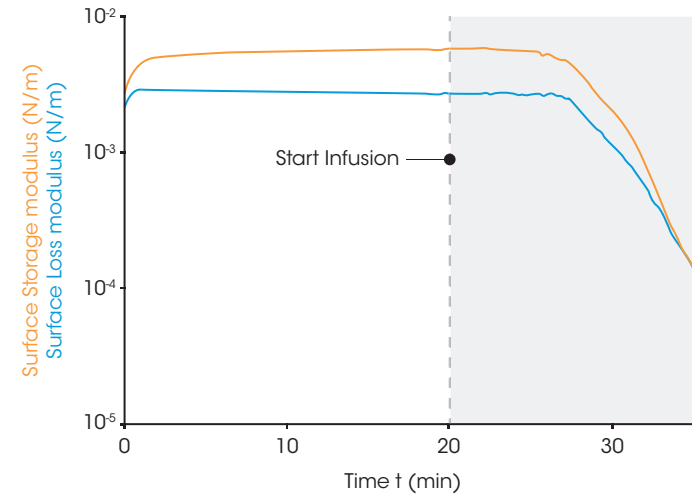

Controlled Infusion of Soap Solution

The interfacial strength of a protein network adsorbed at an oil/water interface can be affected by factors such as the pH, salt concentration, and presence of surfactants. In this example, a strong and stable network of bovine serum albumin was formed at the interface between a phosphate-buffered saline solution and dodecane.

Next, the buffer solution in the subphase was exchanged with a very dilute soap solution. Within minutes after the infusion of the soap solution, the interfacial moduli drop several orders of magnitude, reflecting a dramatic destruction of the protein interface. The introduction of the surfactant lowers the surface tension and displaces protein molecules from the interface. Over time, the continued accumulation of surfactant at the interface brings about the catastrophic destruction of the original protein interface through an orogenic displacement or phase separation processes.

Technology

The Interfacial Exchange Cell consists of three key components – the Double Wall Ring geometry, an exchange cell trough with inlet and outlet ports, and a computer-controlled syringe pump. The cell design, based on computational fluid dynamic simulations by Schroyen *et. al.* (1), is optimized to maximize compositional uniformity while maintaining a constant interfacial height and minimize the stress at the interface from pumping fluid into the cell.



Exchange Cell Trough

The specially-designed double wall interfacial trough (2) features strategically placed fluid inlet and outlet ports to exchange the subphase during a rheological measurement. During the experiment, the new subphase is introduced through four ports located at the bottom of the cell while the same volume is simultaneously removed through four ports located just below the fluid/fluid interface. This concurrent exchange and the balanced trough design ensures uniform infusion and withdrawal guaranteeing a constant subphase volume and interface location throughout the test.

(1) Schroyen *et. al.*, *Rheologica Acta*, Volume 56, Issue 1, pp1-10

(2) U.S. Patent # 7,926,326

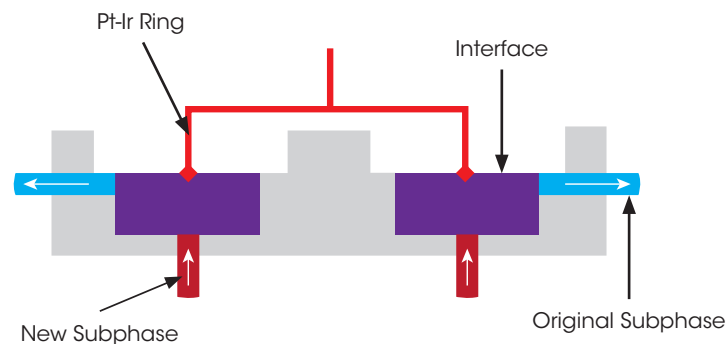

Double Wall Ring

The Interfacial Exchange Cell uses the ultra-low inertia Double Wall Ring (DWR) as the measuring geometry. Featuring a large diameter and a diamond shaped cross-section to "pin" the interface to the ring, the DWR is the preferred platform for sensitive, quantitative interfacial rheology data.



Syringe Pump

The subphase exchange is precisely executed by a simultaneous infuse/withdraw syringe pump that is directly controlled and programmed through TRIOS software. A pair of syringes at each side allow for a complete and uniform exchange of the subphase volume while maintaining a constant interfacial height. At a representative 6 mL/min flow rate, the subphase volume inside the cell can be completely exchanged within 8 minutes.

TRIBO-RHEOMETRY | ACCESSORY

Tribology

Tribology is defined as the study of interacting surfaces undergoing relative motion. The new Tribo-Rheometry Accessory, available for all DHR models, enables the capability to make coefficient of friction measurements between two solid surfaces under dry or lubricated conditions. The unique self-aligning design ensures uniform solid-solid contact and axial force distribution under all conditions. A modular set of standard and novel geometries offers a choice of different contact profiles and direct simulation of end-use conditions. Accurate and precise control of axial force, rotational speed, and temperature inherent to TA Instrument rheometers provides for the best and widest range of friction measurements.

The advanced TRIOS software offers easy setup and control of tribo-rheometry tests and contains a complete set of variables required for data analysis including the coefficient of friction (μ), load force (F_L), friction force (F_F) and Gumbel number (G_u). These may be used to construct Stribeck curves, static friction measurements, or explore specific combinations of temperature, contact force, and motion.

Features and Benefits

- Compatible with Advanced and Stepped Disposable Peltier Plates, Environmental Test Chamber and Relative Humidity Accessory
- Characterize materials wear and coefficient of friction under dry or lubricated conditions
- Unique self-aligning design for best solid-solid contact
- Modular set of geometries offers choice of contact profiles
- Interchangeable parts for customized substrates
- Automatic software calculation of relevant friction parameters
- Easy installation and removal





The Tribo-Rheometry Accessory is compatible with Peltier Plates (Advanced, Stepped Disposable), Environmental Test Chamber (ETC) and the Relative Humidity Accessory* combining accurate and stable temperature control with the flexibility to operate under different environmental conditions. The choice of four standard geometries - Ring on Plate, Ball on Three Plates, Three Balls on Plate, and Ball on Three Balls - meets the diverse requirements of tribology applications and offers a variety of contact profiles. The Ring on Plate geometry may also be configured as a partitioned ring, which permits the replenishment of lubricant between the two solid surfaces. The accessory's versatile configurations and easily interchangeable substrates are ideal for studying the effect of friction and long-term wear on materials ranging from automotive components and greases, lubrication in prosthetic devices, and the performance of personal care creams and lotions.

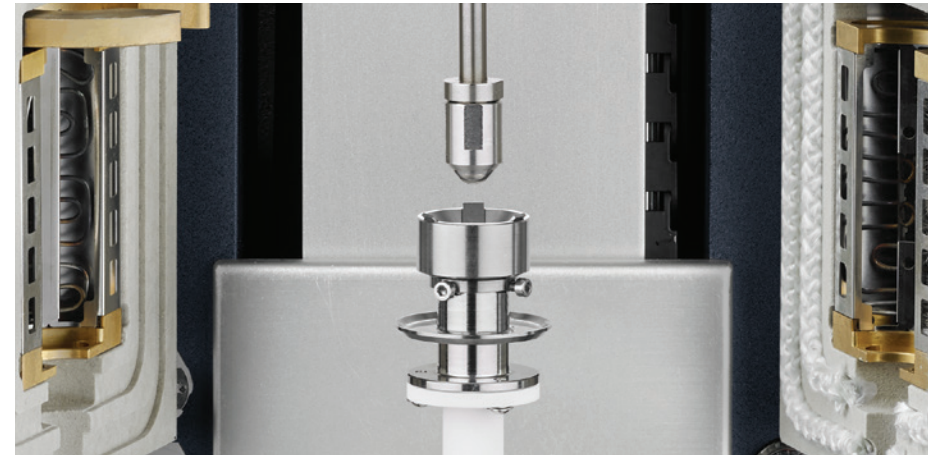

Friction Measurement of Toothpaste

The accompanying figure shows the coefficient of friction profiles of two commercially available toothpastes tested between textured PMMA plates (acting as tooth substitutes) using the ring on plate configuration. The whitening toothpaste, with abrasive particles, has higher friction at low speeds, but the gel toothpaste's friction profile shows a rapid increase at higher speeds. This behavior can be explained by comparing the flow curves of the two toothpastes - although both materials are shear thinning, the viscosity of whitening toothpaste decreases more rapidly than the gel toothpaste. This results in increased hydrodynamic drag and greater friction at higher rotation speeds.

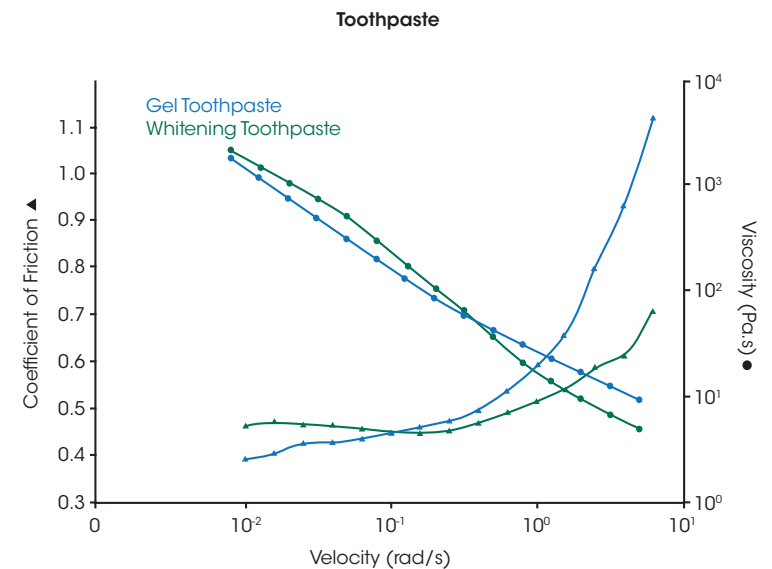

MAGNETO-RHEOLOGY | ACCESSORY

Magneto-Rheology

The new MR Accessory enables the complete characterization of magneto-rheological fluids under the influence of a controlled field. Applied fields up to 1 T and a sample temperature range of -10 °C to 170 °C make the MR Accessory ideal for all studies of MR fluids and ferrofluids.

The MR Accessory applies a controlled field through an integrated electro-magnetic coil located below the sample. This coil operates in conjunction with an upper yoke to deliver a homogeneous magnetic field that is normal to the plate surface. The system includes a channel to accommodate an optional Hall probe for real-time measurement and closed-loop control of the sample field.



Features and Benefits

- Smart Swap™ technology for quick installation
- Complete control of magnetic field profiles, including: constant, step, ramp, sine wave, triangle wave, and wave functions with field offset
- Patented Force Rebalance Transducer (FRT) minimizes axial compliance

Precise, Stable Temperature Control

Sample temperature control and magnetic coil stabilization are achieved through accurate liquid temperature control. The upper yoke is thermally conductive, ensuring temperature uniformity throughout the sample thickness. In all cases, sample temperature is always monitored by a probe directly located beneath the plate surface and recorded in the data file. Precise control of sample temperature is provided by closed-loop control of the fluid circulator temperature, eliminating temperature drifts and offsets.

Specifications	
Sample Temperature	5 °C to 75 °C (standard) -10 °C to 170 °C (extended)
Sample Temperature Measurement and Closed-Loop Control*	Standard
Applied Field	-1 T to 1 T
Magnetic Field Measurement and Closed-Loop Control	Optional
Test Geometries	20 mm parallel plate 20 mm, 2° cone

*When configured with appropriate computer-controlled circulator.

MR Fluid Structure Formation

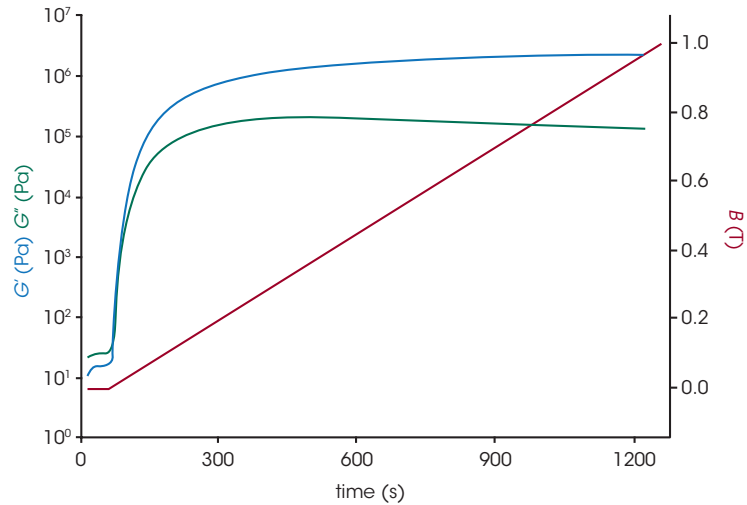

Rheology of MR Fluids

Magnetorheological fluids consist of ferrous colloidal particles suspended in a carrier fluid. The data in the plot reveal the extent of structural development in an MR fluid with increasing magnetic field through the storage and loss moduli. The early time-dependence before field application indicates ongoing development of field-independent structure. On increasing the strength of the applied magnetic field, structural reorientation results in a drastic increase in the storage modulus, leading to sample gelation.

MR Fluid Viscous Response

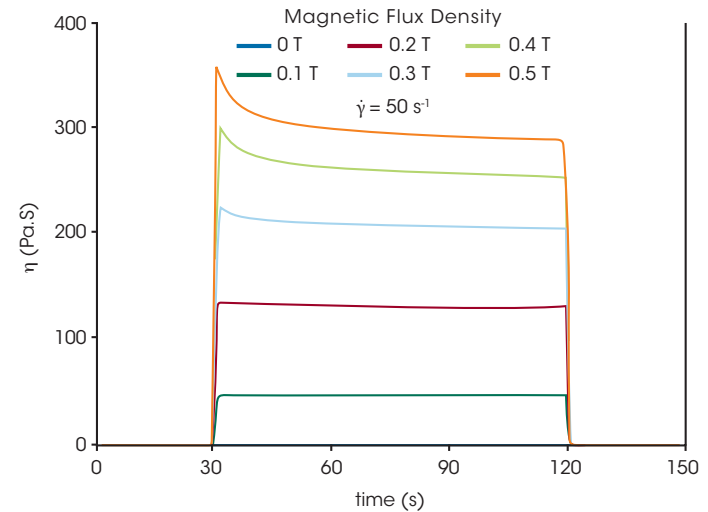
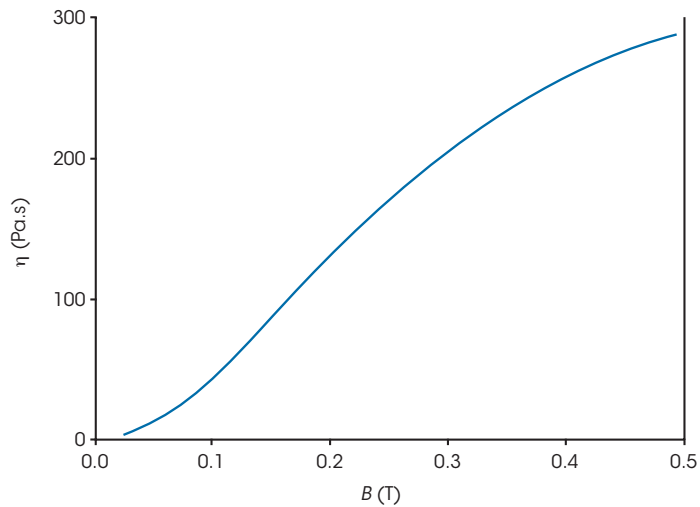

MR fluids tend to show a non-linear viscosity dependence on the magnetic field as shown in the plot above. The viscosity shows a rapid increase with field strength at low fields. The rate of viscosity change with field starts to gradually decrease as the sample approaches its saturation strength. Understanding an MR fluid's saturation field strength is critical to the design of high performance devices, such as, brakes, clutches, and dampers.

The data above display the transient response of an MR fluid to step changes in the magnetic field. Changing the field strength provides a direct way to tune the sample viscosity. At larger field strengths, the sample develops a structure dependent on field and shear application time that results in a thixotropic response.

RELATIVE HUMIDITY | ACCESSORY

DHR-RH

The DHR-RH Accessory is a new environmental system for the Discovery Hybrid Rheometer that enables accurate control of sample temperature and relative humidity. The DHR-RH Accessory employs a custom-designed humidity and temperature chamber that is optimized for rheological measurements. The DHR-RH Accessory provides stable, reliable control of temperature and humidity over a wide range of operating conditions and successfully prevents condensation, a common occurrence in controlled-humidity environments which makes accurate control of relative humidity impossible.

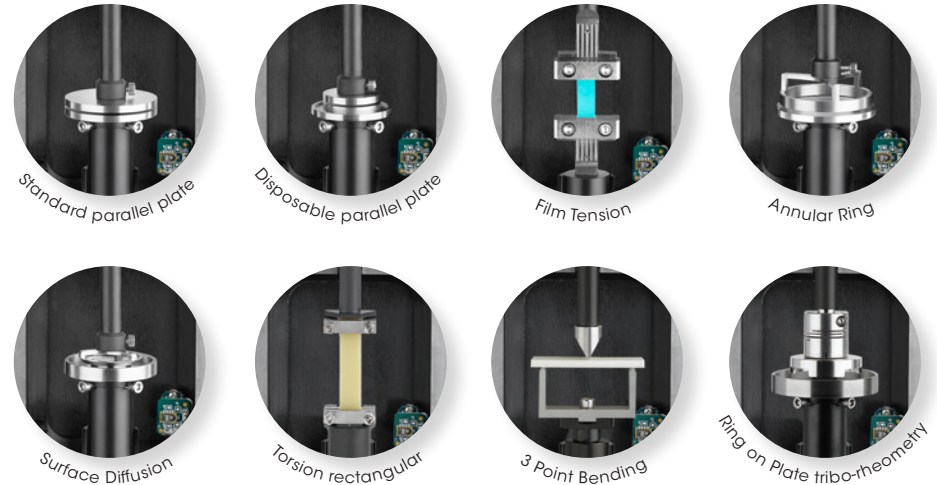
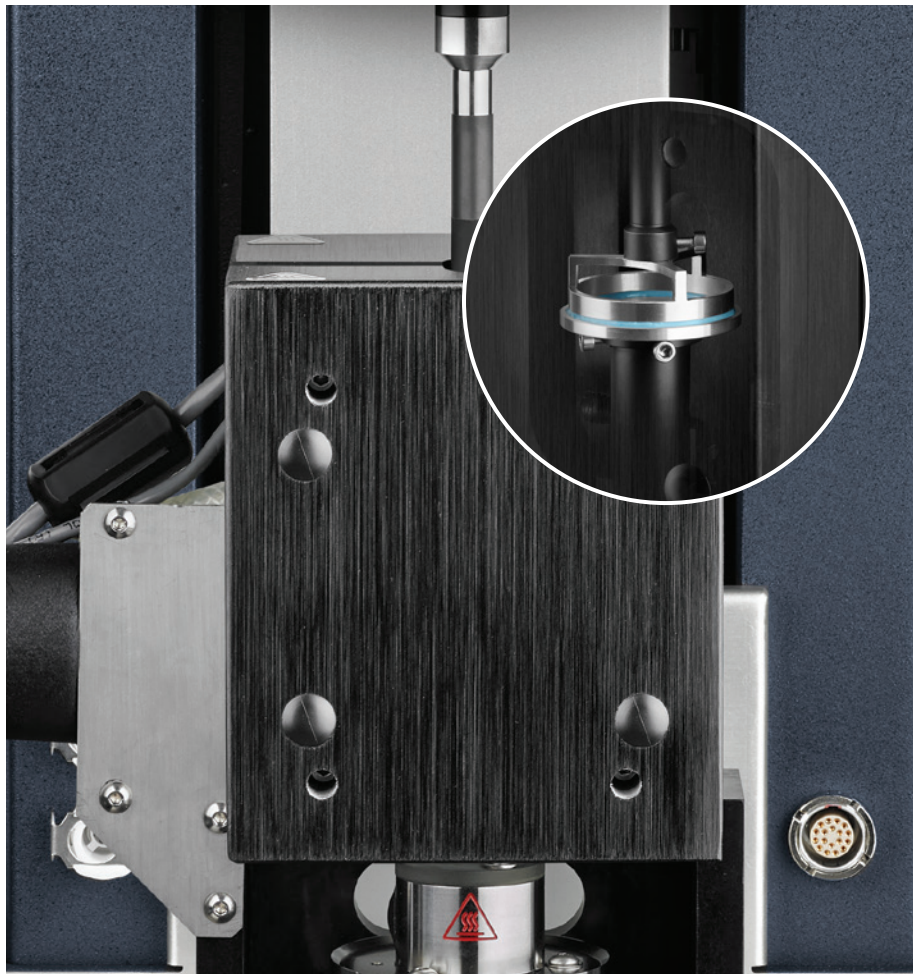

Features and Benefits

- Uniform, reliable control of temperature and relative humidity over full operating range
- Optimized gas flow eliminates interference from laboratory conditions
- Completely integrated system including native control and coordination of temperature, humidity, and rheology through powerful TRIOS software
- Wide variety of test geometries:
 - Standard parallel plate
 - Disposable parallel plate
 - Film Tension
 - Annular Ring
 - Surface Diffusion
 - Torsion Rectangular
 - Three-Point Bending
- Innovative geometries for RH: true humidity-dependent rheology, not dominated by diffusion
- True Dynamic Axial Film Tension
- Tribo-rheometry – Ring on plate, 3 Balls on Plate
- DMA geometries for true dynamic deformation in the axial direction: film tension, 3-point bending, single/dual cantilever, compression

Specifications	
Temperature Range	5 °C to 120 °C
Humidity Range	5% to 95%
Humidity Accuracy	5-90% RH: ± 3% RH > 90% RH: ± 5% RH

Adhesive curing under controlled humidity conditions

The curing process of poly(vinyl acetate) (PVA) adhesives is driven by the loss of moisture from the glue to the atmosphere. The rate of this moisture loss is governed by the ambient humidity. While curing kinetics is important, a reliable adhesive bond also depends on a sufficient modulus. The accompanying data illustrates the curing time and bulk modulus of a PVA glue at three different levels of relative humidity. The data demonstrate that higher humidity levels slow the curing process, but do not impede the final modulus value. These measurements were performed using the Annular Ring geometry, which allows for the determination of kinetic processes that are not limited by diffusion within the sample, and also provides quantitative bulk rheological properties which are needed to evaluate adhesive performance.

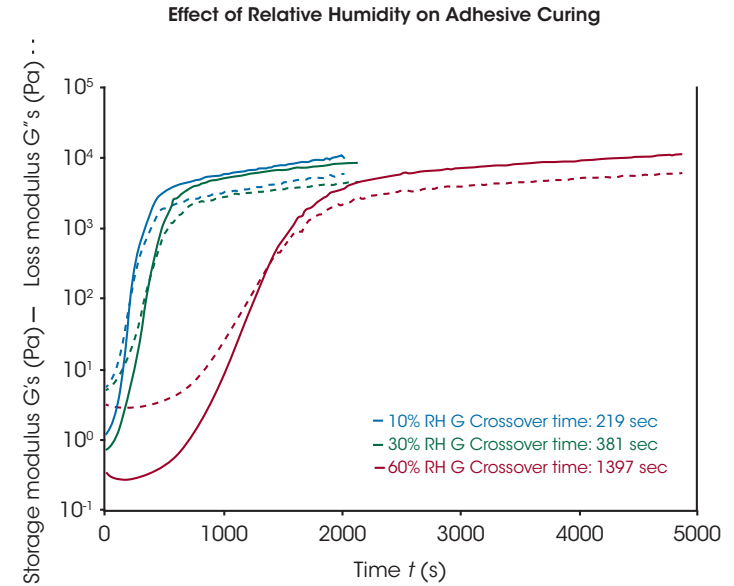

Fuel cell membrane performance

Fuel cell proton exchange membranes have performance characteristics that are strong functions of gas humidity. At low relative humidity (RH), membrane conductivity drops and the efficiency of the membranes decreases. For this reason, the operating environment is maintained at a high RH. These membranes are also strongly hygroscopic, absorbing moisture which leads to plasticizing and volumetric expansion. The axial film tension accessory was used to simultaneously measure the tensile modulus and monitor the change in sample length as a function of temperature and humidity for a commercial fluoropolymer fuel cell membrane. This information is important in designing for load and vibration tolerance, as well as dimensional stability with respect to hygroscopic expansion.

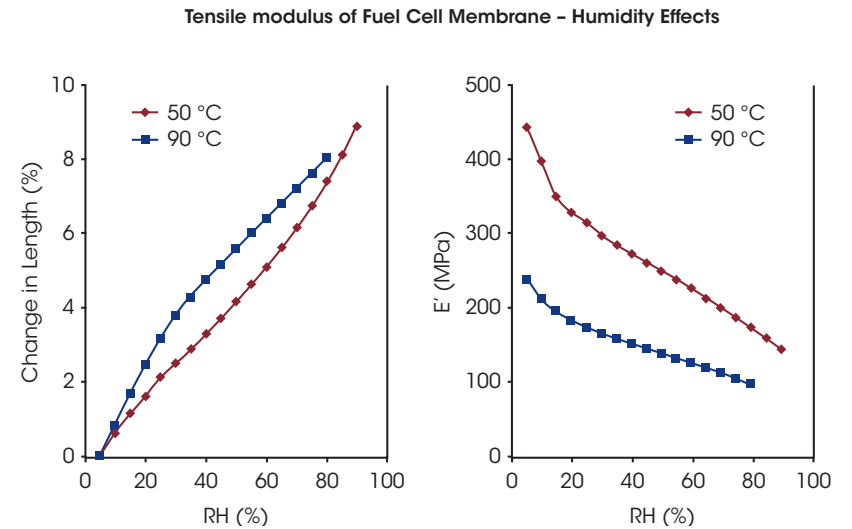

ELECTRO-RHEOLOGY | ACCESSORY

Electro-Rheology Accessory (ER)

Electro-Rheological, or "ER", fluids are suspensions of extremely fine non-conducting particles in an electrically insulating fluid. These materials show dramatic and reversible rheological changes when the electric field is applied. The Discovery Hybrid Rheometer ER accessory provides the ability to characterize ER fluids up to 4,000 volts using either parallel plate or concentric cylinder geometries. The accessory is available for all DHR models and compatible temperature systems include the popular Peltier Plate (-40 °C to 200 °C) and Peltier Concentric Cylinder (-20 °C to 150 °C). A custom waveform and function generator enables the user to program a wide range of voltage profiles directly in TRIOS Software. Voltage Profiles include: constant voltage, step voltage, ramp voltage, sine wave voltage function, triangle wave voltage function, and wave functions with DC offsets. There are no limitations to the type of rheological experiments that can be performed with this accessory. A protective polycarbonate shield with trigger interlocks is also included with the accessory to provide safety from electrical shocks.

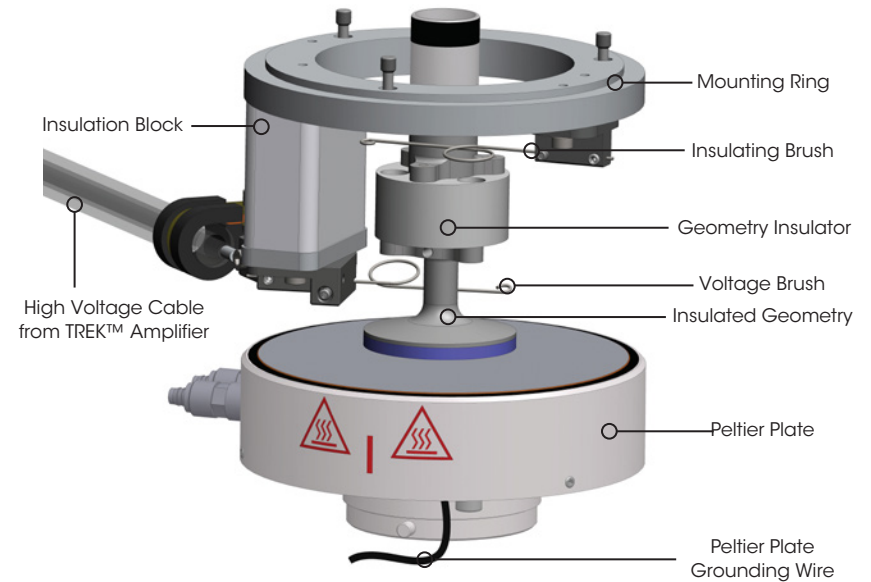

Features and Benefits

- Smart Swap™ technology
- Easy installation and removal
- Compatible with Peltier Plate and Peltier Concentric Cylinder
- 25 mm and 40 mm diameter plates with ceramic insulation
- 28 mm diameter DIN concentric cylinder rotor
- Wide voltage range: 4000 VDC, 4000 VAC (8000 V peak-to-peak)
- Compatible temperature systems
 - Peltier Plate: -40 °C to 200 °C
 - Peltier Concentric Cylinder: -20 °C to 150 °C
- Fully programmable from TRIOS Software
- Protective shield with trigger interlocks included for safety
- Flexible voltage profile programming including:
 - constant voltage
 - step voltage, ramp voltage
 - sine wave voltage function
 - triangle wave voltage function
 - wave functions with DC offsets

Step Voltage on Starch Suspension under Steady Shear

A 10% starch solution in silicon oil demonstrates dramatic and reversible changes in structure under the application of high voltage. The figure shows time-dependent viscosity with varying DC voltage, from 500 to 4000 V, applied for 100 s. The underlying rheological test is a constant rate at 1 s^{-1} , which minimizes the disturbance to the structuring process. When an electrical field is applied, polarization of the starch particles in the non-conducting silicone oil leads to stringing of the starch particles and aligning them between the electrode plates. This orientation is responsible for the strong viscosity increase. The time to align the particles depends on the viscosity of the suspending fluid and the strength of the electrical field. Because under the applied shear rate, deformation of the structuring process is not completely eliminated, a maximum viscosity is observed when the dynamic equilibrium between forming and breaking of strings of aligned particles is achieved.

Sinusoidal Voltage Oscillation under Steady Shear

Electro-Rheological materials demonstrate interesting responses to AC voltage profiles. The figure to the right shows the viscosity response at a constant shear rate when an AC voltage with a peak maximum of 4000 V and a frequency of 0.01 Hz is applied to a starch in oil suspension. Under this applied electrical profile, it can be seen that the viscosity changes with twice the frequency of the voltage - put another way, the viscosity change is in phase with the absolute magnitude of the voltage. This behavior occurs because the viscosity is independent of the sign of the voltage. When the electrical field has zero voltage, the viscosity has the lowest value.

DC Voltage Response of a Starch in Oil Suspension

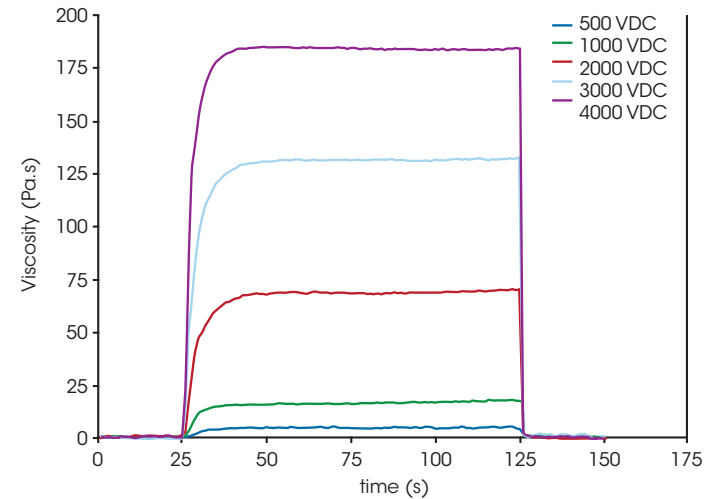

AC Voltage Response of a Starch in Oil Suspension

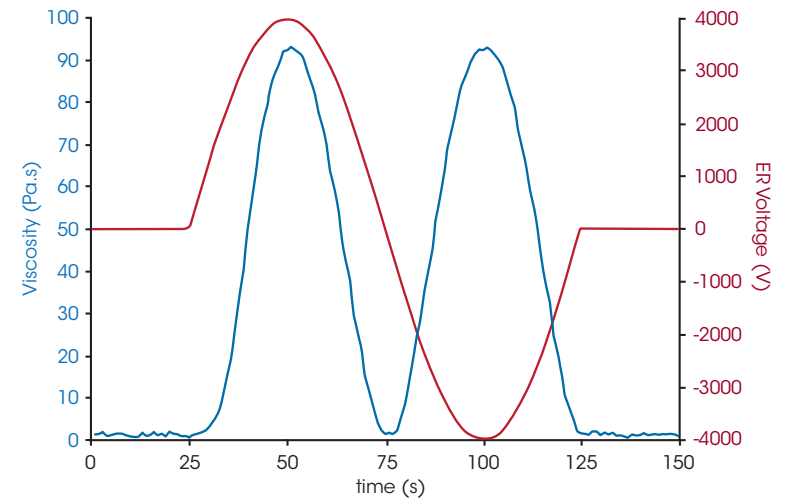

UV CURING | ACCESSORIES

UV Curing Accessories

UV-curable materials are widely used for coatings, adhesives, and inks. When these materials are exposed to UV radiation, a fast cross-linking reaction occurs, typically within less than a second to a few minutes. Two Smart Swap™ accessories for rheological characterization of these materials are available for all DHR models. One accessory uses a light guide and reflecting mirror assembly to transfer UV radiation from a high-pressure mercury light source. The second accessory uses self-contained light emitting diodes (LED) arrays to deliver light to the sample. The UV Curing accessories include 20 mm quartz plate, UV light shield, and nitrogen purge cover. Optional temperature control to a maximum of 150 °C is available using the Upper Peltier Plate (UPP) option. Disposable plates are available for hard UV coatings, which cannot be removed from the plates once cured.

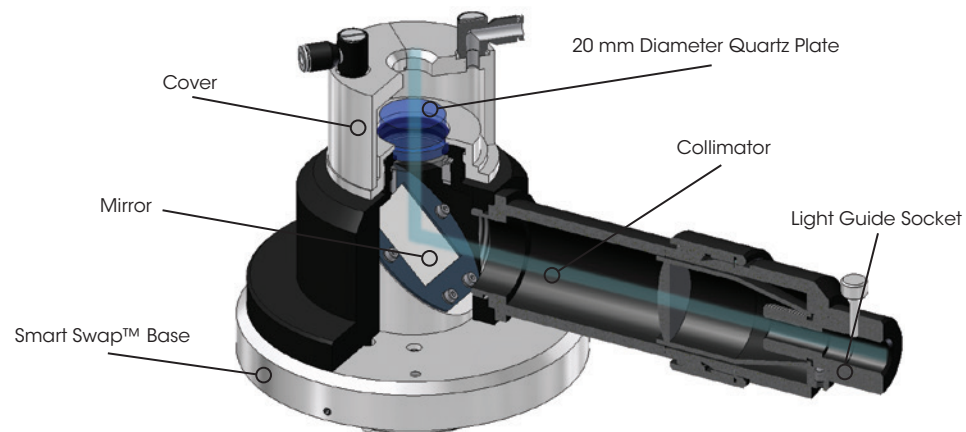

UV Light Guide Accessory Technology

The UV Light Guide accessory includes a lower Smart Swap™ assembly with quartz plate, light source mount, collimator, 5 mm diameter light guide, and UV mercury lamp source (Excelitas Omnicure S2000). It provides a broad wavelength spectrum from 320 nm to 500 nm, with a primary peak at 365 nm. The high pressure 200 W mercury vapor lamp provides a source intensity up to 300 mW/cm². External filter holder and filters are available for the light source.

Features and Benefits

- Smart Swap™ technology
- Convenient compact
- Collimated light and mirror assembly ensure uniform irradiance across plate diameter
- Maximum intensity at plate 300 mW/cm²
- Broad range spectrum with main peak at 365 nm
- One system with specific wavelengths accessible through filtering options
- Cover with nitrogen purge ports
- Optional disposable acrylic plates
- Optional temperature control with Upper Peltier Plate (UPP) to 150 °C
- Software programmable trigger time and intensity

UV LED Accessory Technology

The UV LED accessories use arrays of light emitting diodes that provide single peak wavelength light sources. The LED array is mounted on a PCB and is fixed to a water jacket that cools the LED's during use. Like the UV light guide system, LED's are pre-aligned to ensure uniform irradiance across the surface of the plate. There are two LED accessories available at wavelengths of 365 nm and 455 nm. The maximum output UV intensity is 150 mW/cm² and 350 mW/cm², respectively. They are fully integrated with the rheometer through a Smart Swap™ option. Trigger time and intensity are conveniently programmed through the software.

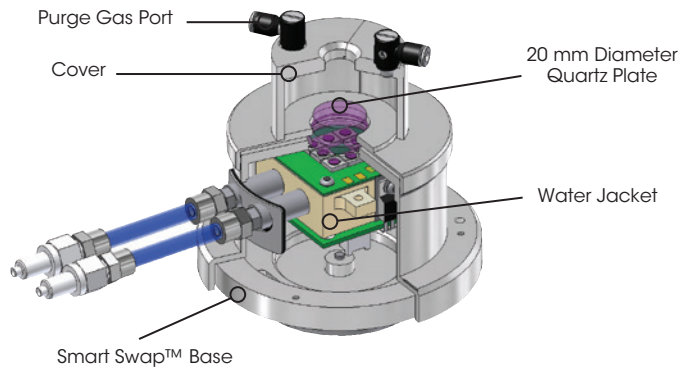

Features and Benefits

Smart Swap™ technology

- New technology replaces mercury bulb systems
- 365 nm wavelength with peak intensity of 150 mW/cm²
- 455 nm wavelength with peak intensity of 350 mW/cm²
- No intensity degradation over time
- Even intensity across plate diameter, LED positioned directly below plate
- Compact and fully integrated design including power, intensity settings and trigger
- Cover with Nitrogen purge ports
- Optional disposable Acrylic plates
- Optional temperature control to 150 °C

Effect of UV Curing Intensity

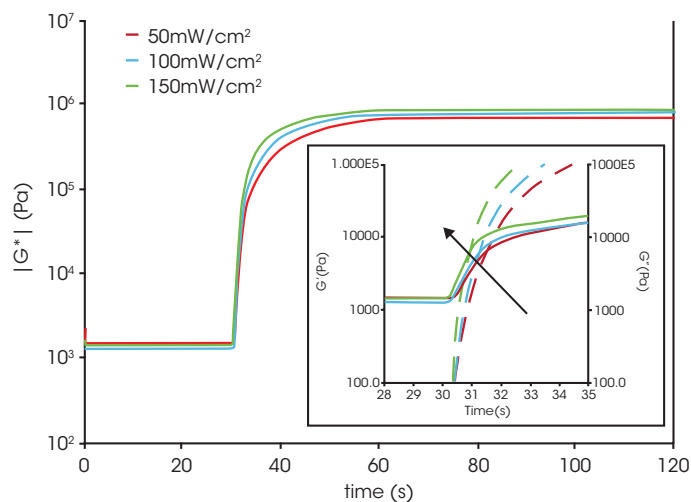

UV Accessory Application

These accessories allow the study of UV curing reactions by monitoring the elastic (G') and viscous (G'') moduli. The example on the left shows results of a pressure sensitive adhesive, (PSA), characterized with the UV Light Guide Accessory. The PSA was held at an isothermal temperature of 25 °C and the curing profile was measured at radiation intensities from 50 mW/cm² to 150 mW/cm². The sample is measured for 30 seconds before the light is turned on. The data show faster reaction kinetics with increasing intensity, as evidenced by the shorter time for crossover of G' and G'' . Similar results can be obtained with controlled temperature, where the reaction is seen to occur more quickly at higher temperatures. The curing reaction happens in less than two seconds. The fast data acquisition of the Discovery Hybrid Rheometers (up to 50 pts/sec) enables clear identification of the liquid to solid transition. Note that changing the intensity and temperature by small amounts shifts the crossover point by a fraction of a second. This information is important for understanding adhesive control parameters for high-speed UV curing processes, as well as for understanding differences in initiators when formulating materials.

RHEO-IMPEDANCE SPECTROSCOPY | ACCESSORY

Rheo-Impedance Spectroscopy (RHEO-IS)

Rheo-Impedance Spectroscopy offers powerful insights into microstructure of complex fluids such as battery electrode slurries, emulsions, paints, coatings and more. Coupling dielectric impedance spectroscopy with the DHR's rheology measurements empowers users to characterize shear-induced changes in sample microstructures under process-relevant conditions such as mixing, storage and coating. Simultaneous precise measurements of viscosity, yield stress, viscoelasticity and recovery deliver new insights connect flow properties to underlying changes in microstructure.

Battery electrode slurry formulation and process development is guided by impedance spectroscopy. Initial impedance measurements performed without applied shear indicate the dispersion of conductive material in the slurry after mixing. Simultaneous impedance and rotational deformation directly measures shear-induced changes in the microstructure, replicating slurry coating conditions and enabling measurements of time-dependent recovery after shear. These new insights verify the electrically conductive network is maintained in the finished electrode and ensure successful battery performance.

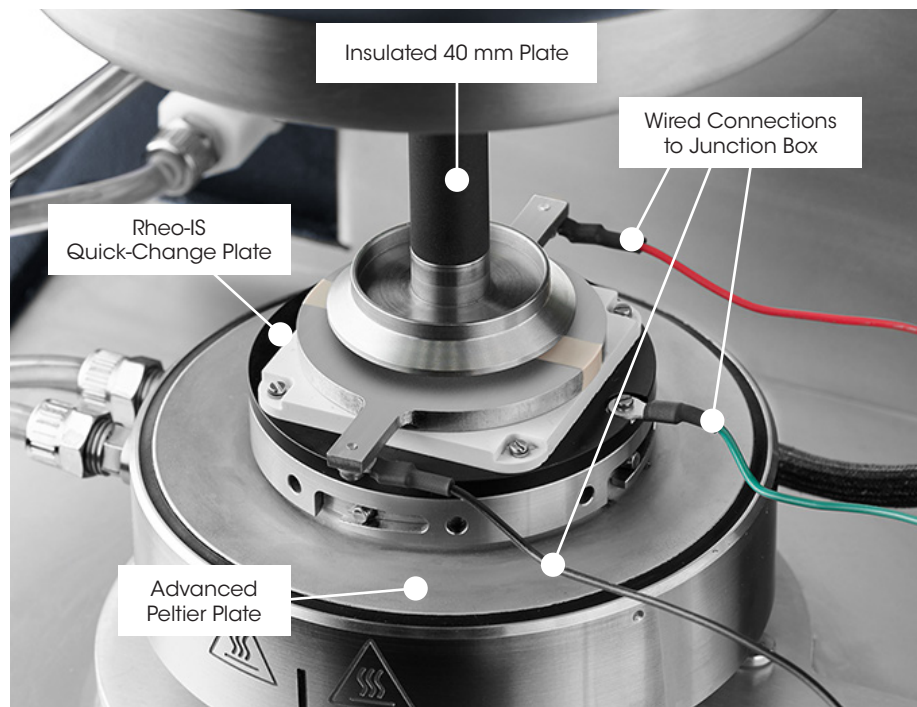

Rheo-Impedance Spectroscopy Accessory	
Unique Friction-Free technology	Minimum oscillation torque 0.3 nN.m *
Peltier Temperature control	15 °C to 100 °C
40 mm stainless steel plate (included)	Sample volume < 2 mL
Customized solvent trap (included)	Prevent evaporation during measurement
TRIOS software integration of LCR data	Reactance, resistance, loss tangent, impedance, admittance, capacitance, conductivity, permittivity, susceptance; Nyquist plot, Bode plot

Compatible LCR Meters	Frequency	Voltage
HIOKI™ - IM3536	4 Hz to 8 MHz	0.01 V to 5 V
Keysight™ - E4980AL	20 Hz to 1MHz	0.001 V to 2 V
Keysight™ - E4980A	20 Hz to 2 MHz	0.005 V to 20 V

*minimum torque depends on instrument model

Technology

The DHR's Rheo-Impedance Spectroscopy accessory achieves unmatched data quality in both dielectric impedance and rheology measurements. Traditional approaches to combined rheology-dielectric impedance require an electrical contact with the upper tool, either hard-wired, spring contact or liquid electrolyte, limiting measurement range. The Rheo-IS accessory positions both electrodes on a lower plate, using an insulated upper parallel plate geometry as a conductor, eliminating any need for contact with the upper tool. This unique design enables unlimited Rheo-Impedance measurements:

- Simultaneous impedance and steady shear measurements under process-relevant conditions
- Friction-free: absence of wire or spring contacts allows for full range of the DHR's torque sensitivity, enabling precise characterization of viscosity, yield stress, viscoelasticity and structure recovery
- Dielectric impedance measurements up to 8 MHz, without the limitations and experimental challenges of a liquid electrolyte contact
- Installation in under 5 minutes: Rheo-IS Quick Change plate mounts to Advanced Peltier Plate for controlled temperature
- LCR meter calibration, measurement, signals and data analysis integrated in TRIOS software



Cathode Slurry Formulation

Rheo-Impedance Spectroscopy offers powerful insights into cathode slurry formulation, evaluating each ingredient's impact on both rheology and conductive network distribution. A cathode slurry was prepared by first mixing carbon black and PVDF in NMP (Sample A), then adding NMC (Sample B). Impedance measurements were made on the material at both steps, over a range of increasing shear rates. Sample A's viscosity is significantly higher, despite its low solids content (8%), compared to Sample B with added NMC (solid content: 72%). NMC particles aid in dispersing carbon black agglomerates into a more uniform network, resulting in a reduced viscosity preferable for coating.

Simultaneous impedance measurements support this explanation. A Nyquist plot of Sample A shows its impedance changes significantly under varying shear rates, indicative of a changing network of carbon black agglomerates. In contrast, Sample B shows consistent impedance across all shear rates. The incorporation of NMC aids in the distribution of carbon black, resulting in a more stable electrically conductive network. This shear-stable microstructure is favorable for production, ensuring the conductive network is maintained in the finished cathode.

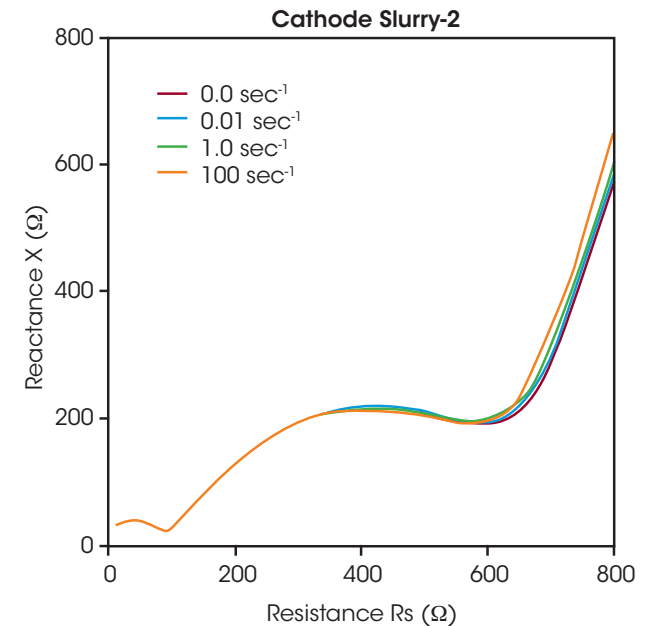
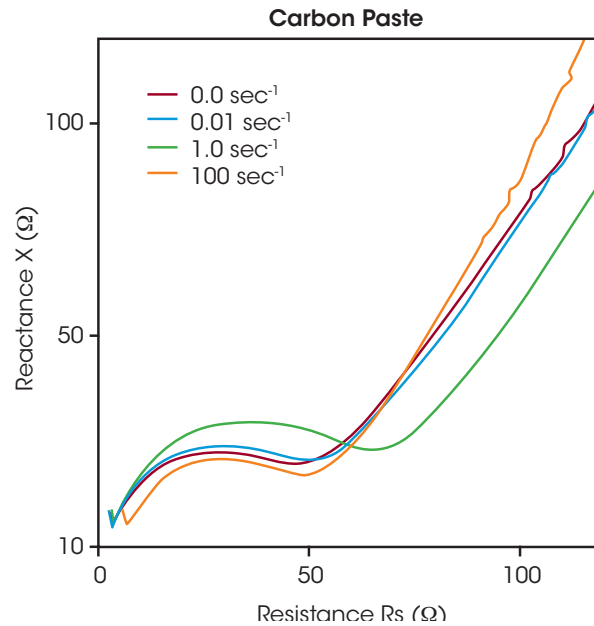
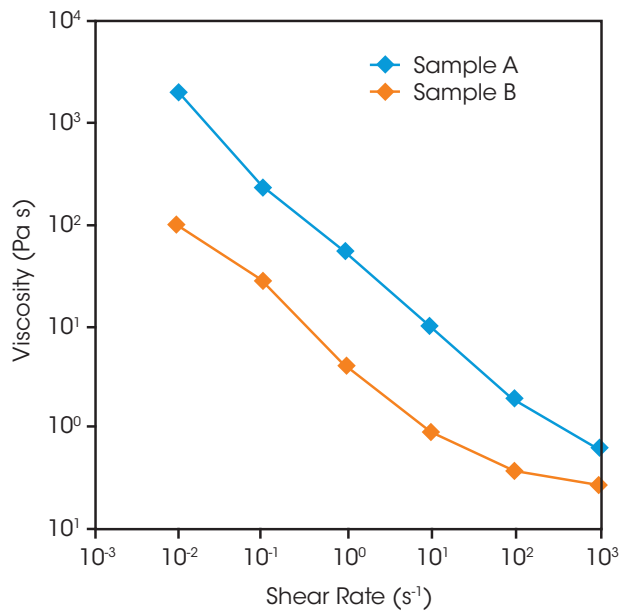

DIELECTRIC MEASUREMENT | ACCESSORY

Dielectric Accessory

The Dielectric Accessory extends material characterization capabilities by providing an additional technique similar to dynamic mechanical analysis. In dielectric analysis, an oscillation electrical field (AC Field) is used as opposed to mechanical force (stress) and the oscillating strain is a stored charge (Q) in the sample. The technique measures the degree to which the sample is storing a charge (capacitance) or passing a charge (conductance) through its bulk. The DHR provides a flexible platform for easy test setup and calibration, and data accuracy through standard features such as the Environmental Test Chamber, axial force control, and gap temperature compensation routines. Dielectric analysis is a very powerful technique for characterizing polar materials such as PVC, PVDF, PMMA, and PVA, for phase separating systems, and for monitoring curing kinetics of materials such as epoxy and urethane systems. Dielectric analysis extends the measurable frequency range over traditional dynamic mechanical analysis which is typically limited to 100 Hz.

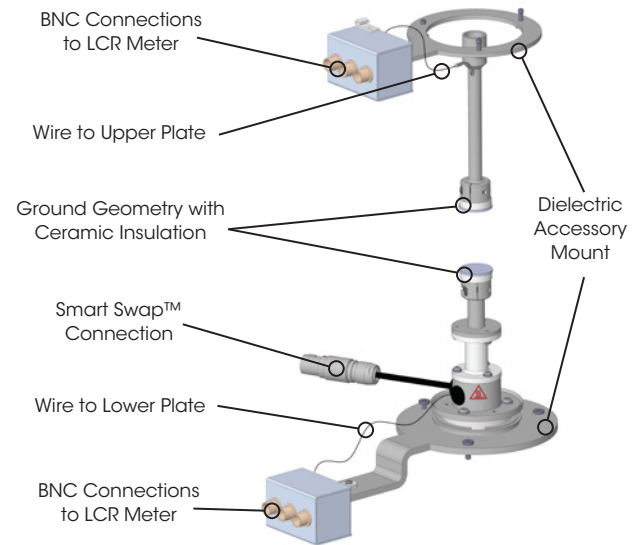

Technology

The Dielectric accessory consists of a special set of 25 mm parallel plates that are fitted with wiring and hardware for interfacing with a dielectric LCR meter (Keysight E4980A or E4980AL LCR) that imposes a signal at a certain voltage and frequency/ies. The voltage range available is between 0.005 to 20 V with a frequency range of 20 Hz to 2 MHz. The Environmental Test Chamber (see page 30) provides temperature control over a range of -160 °C to 350 °C. The accessory allows for the simultaneous collection of rheological and dielectric information, or dielectric measurements can be run independently.

Features and Benefits

- Smart Swap™ technology
- 25 mm diameter plates with ceramic insulation
- Disposable plates for curing system
- Stand-alone dielectric measurements
- Combined rheological and dielectric measurements
- Fully programmable from TRIOS Software
- Time-Temperature Superposition
- Master curve generation
- Wide dielectric frequency range: 20 Hz to 2 MHz
- Easy installation and removal
- Compatible with ETC over a temperature range of -160 °C to 350 °C
- USB Interface

Phase Separation in Cosmetic Creams

Temperature stability of materials such as food and cosmetics is very important for product performance in storage and transportation. Rheological testing is widely used for stability evaluations; however, the ability to simultaneously measure dielectric properties can provide more valuable insight for complex formulations.

An example is shown in the figure to the right for two water-based cosmetic creams tested by cooling from 25 °C down to -30 °C. In comparing only storage modulus, G' , data of the two materials, the POND'S® cream shows little increase followed by a three decade jump at -18 °C, but NIVEA cream exhibits a more continuous change in the modulus over the entire temperature range. One may conclude from the mechanical response alone that the large jump in G' of POND'S at -18 °C is associated with instability. However, having the simultaneous measurement of the loss permittivity, ϵ'' , provides information relating to the change in ion mobility; primarily of the water phase in these samples.

In the ϵ'' the NIVEA shows a two decade jump compared to very little change in the ϵ'' of the POND'S. The large increase in ϵ'' is due to increased ion mobility in the material as the water separates. In the final analysis, phase separation occurs in the NIVEA, not the POND'S. During the cooling process, as phase separation gradually occurs, the water phase grows changing the morphology. As the morphology gradually changes, so too does the G' . The large change in G' of the POND'S is the result of a transition of a more stable and uniform morphology.

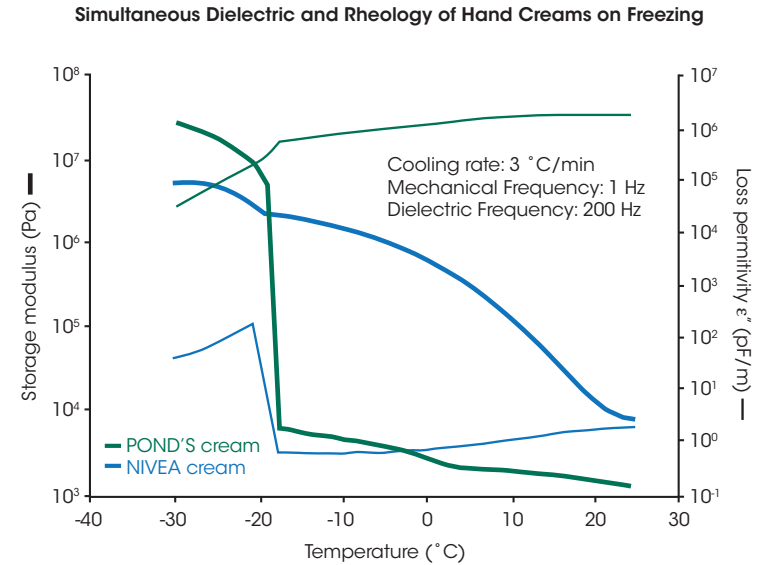

Dielectric Temperature Ramp at Multiple Frequencies

The figure to the right shows a temperature ramp on a Poly (methyl methacrylate), PMMA, sample at four different dielectric frequencies ranging from 1,000 Hz to 1,000,000 Hz. It can be seen here that the magnitude of ϵ' decreases with increasing frequency through the transition region and the peak of the transition in $\tan \delta$ moves to higher temperatures with increasing frequency.

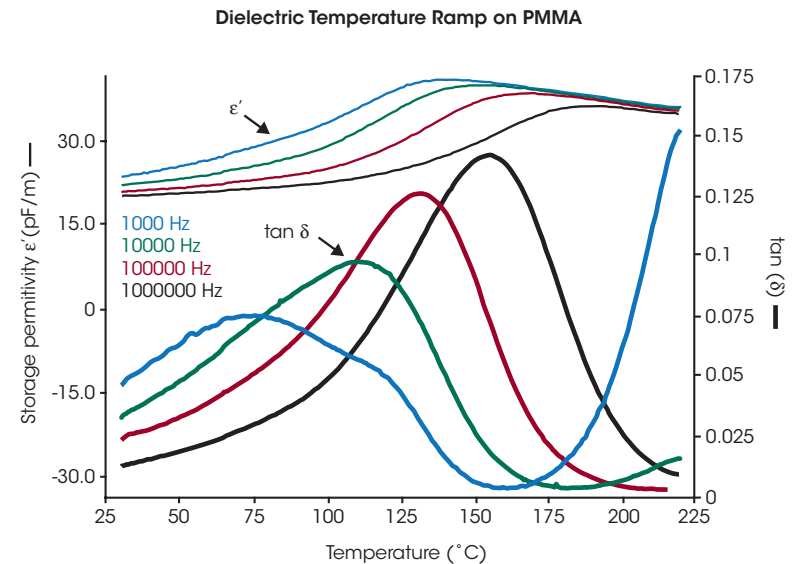

IMMOBILIZATION CELL | ACCESSORY

Immobilization cell

The new Immobilization Cell Accessory for the Discovery Hybrid Rheometer permits the characterization of drying, retention, and immobilization kinetics of paints, coatings and slurries. Solvent is dewatered from the sample through a paper substrate affixed to a perforated lower plate under controlled temperature and vacuum. Rheological changes in the sample during this immobilization process are simultaneously quantified through an oscillatory time sweep test with controlled axial force. Solid state Peltier heating and cooling provides faster, more stable temperature control, and is easier to use than competitive designs that rely on liquid-based temperature control. The DHR Immobilization Cell is a Smart Swap™ system that is extremely easy to install, use, and clean.

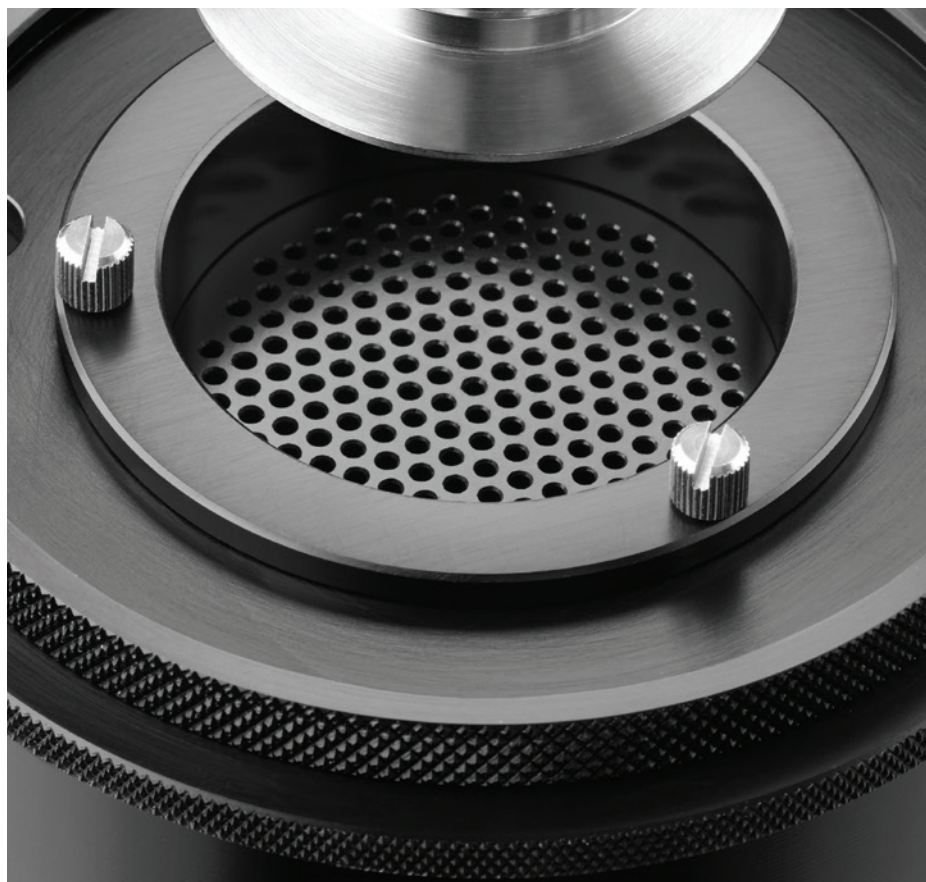

Technology

The Immobilization Cell accessory consists of a temperature-controlled jacket, a perforated platform and substrate clamping ring. Peltier temperature control provides stable, responsive control without a refrigerated circulator. A manifold to control the vacuum and collect waste is connected to the cell. The system is used in conjunction with an upper 50 mm parallel plate geometry.

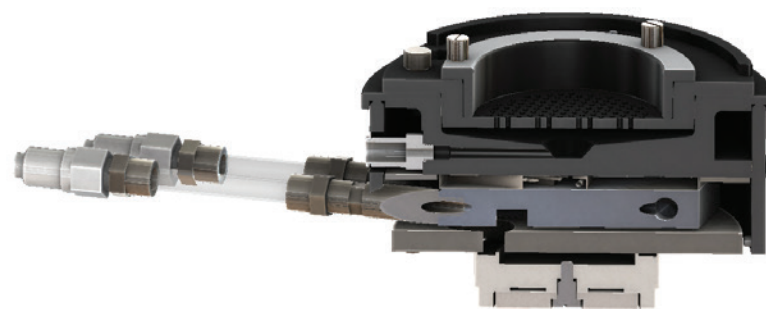

Specifications	
Temperature Range	-10 °C to 180 °C
Temperature Resolution	0.01 °C
Pressure difference between coating and substrate	0 to 85 kPa**
Cell construction	Anodized Aluminum

*With appropriate counter-cooling

**Depends on pump capability

Features and Benefits

- Smart Swap™ technology for quick installation
- Peltier temperature control
- Easy sample cleaning
- Replaceable sieve
- Software-controlled vacuum trigger
- Controlled-stress, -strain, and -rate operation

Characterization of Paint drying

The drying characteristics of an acrylic paint formulation coated onto various paper substrates are illustrated in the figure to the right. With no vacuum applied the acrylic paint dries slowly, as indicated by the gradual increase in complex viscosity. When full vacuum is applied there is an initial decrease in the complex viscosity followed by continuous drying and an associated increase in viscosity. The rate at which drying or settling occurs depends on the particulate properties of the paint, the porosity and density of the substrate, and more.



Acrylic Paint Drying

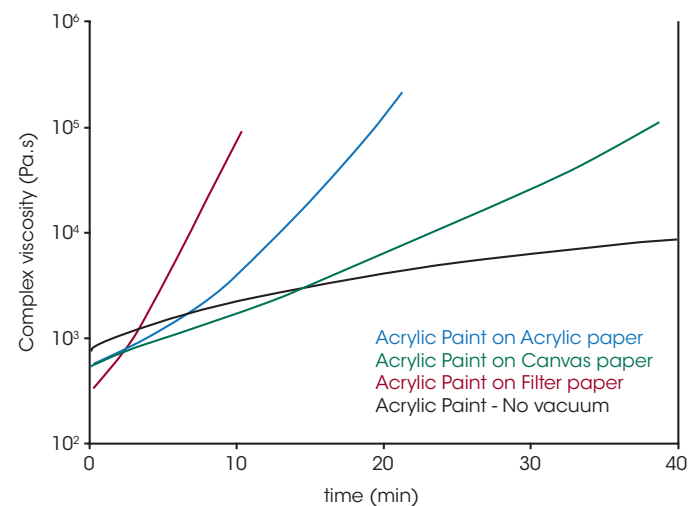

STARCH PASTING CELL | ACCESSORY

Starch Pasting Cell (SPC)

The Starch Pasting Cell (SPC) provides a more accurate and powerful tool to characterize the gelatinization of raw and modified starch products, as well as the properties of the starch gels. It can also be used for characterizing many other highly unstable materials. It uses an innovative impeller design for mixing, reduction of water loss, and control of sedimentation during testing. The actual sample temperature is measured and controlled in a temperature chamber with heating/cooling rates up to 30 °C/min.

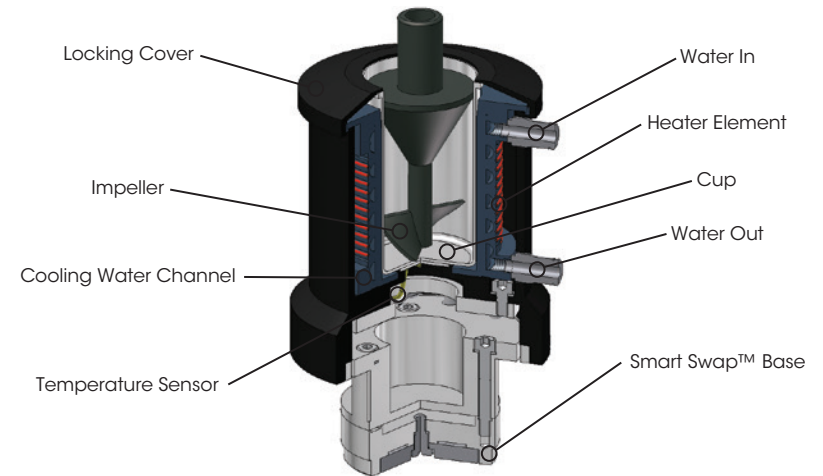

Technology

The SPC consists of the cell jacket, an impeller, and aluminum cup with locking cover. The cell jacket houses a heating coil and liquid cooling channel, which surrounds the Aluminum cup for fast heating and cooling. A Platinum Resistance Thermometer (PRT) is located in intimate contact with the bottom of the cup for precise and accurate sample temperature control. The impeller is designed with blades at the bottom for sample mixing. Solvent loss is minimized via a conical ring at the top of the rotor, which acts to condense water (or other solvents) that vaporizes during heating, and return it to the bulk sample.

Features and Benefits

- Smart Swap™ technology
- Heating/Cooling rates up to 30 °C/min
- Higher accuracy for greater reproducibility
- Robust Cup and Impeller
- Impeller keeps unstable particles suspended in liquid phase during measurements
- Impeller design minimizes loss of water or other solvents
- Sample temperature measured directly
- All rheometer test modes available for advanced measurements on gelled starches and other materials
- Optional conical rotor for traditional rheological measurements

Gelatinization of Starch Products

Starch is not only a food product; functionally modified starches are widely used in industries including adhesives, paper, coatings, wood, packaging, pharmaceutical, and many others. When starch is heated above a critical temperature, the starch granules undergo an irreversible process, known as gelatinization. The properties of the starch gels depend on the origin of the raw starch (crop, potatoes, etc.), the environmental conditions (seasons) or the modification. The viscosity curve, referred to as pasting curve, produced by heating and cooling starches generally has a similar characteristic shape. The figure to the right shows two scans each of both a Dent Corn and Waxy Maize starch. The benefit of the DHR starch cell design can easily be observed in the unprecedented reproducibility of the pasting curves for these two starch products.

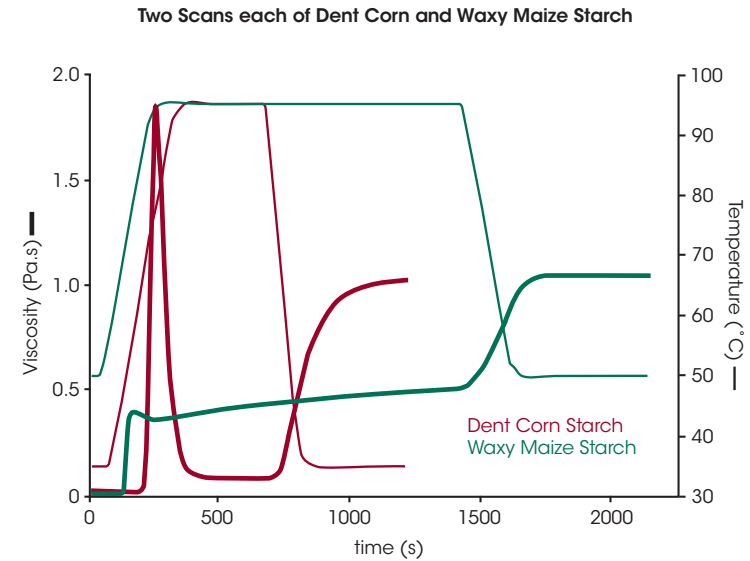

Advanced Starch Rheology

In addition to measuring the characteristic pasting curve of starch products, the starch cell brings new testing capabilities for measuring properties of the starch gels. The figure to the right shows additional data obtained on Dent Corn starch using an oscillation test to monitor the gelation process of the starch under negligible shearing. In this test, the sample is sheared while ramping temperature to keep starch particles suspended. At 75 °C, when the viscosity is high enough to inhibit particle settling, the steady shear was stopped and testing was continued at a small oscillating stress. The figure shows storage modulus, G' , and the loss modulus, G'' , which provide extremely sensitive information about the structural characteristics of the starch gelation and final gel. This enables the development of valuable structure-property relationships. The ability to make these sensitive measurements is not possible on traditional starch characterization instrumentation.

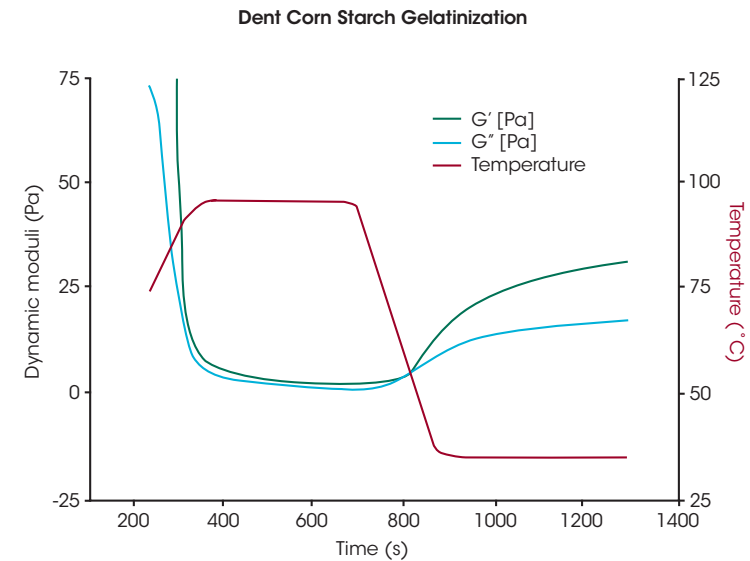

RHEO-RAMAN | ACCESSORY

Rheo-Raman Accessory

The new Rheo-Raman Accessory for the Discovery Hybrid Rheometers allows for simultaneous collection of Raman spectroscopy data during rheology experiments. Raman spectroscopy is a technique that provides critical information about molecular structure and bonding and can elucidate intermolecular interactions of pure components and mixtures. This includes information about a material's crystallinity and conformational order. The Rheo-Raman Accessory from TA Instruments integrates with the iXR Raman Spectrometer from Thermo Fisher Scientific to provide a turnkey, safe system with Class 1 laser certification.

Features and Benefits

- Integrated operation with Thermo Fisher™ iXR Raman spectrometer
- Choice of different lasers for maximum versatility
- 32 nm, 532 nm and 785 nm (high brightness, high power options)
- User installable laser sets — quick and easy to switch lasers
- Multiple interlocks for class 1 laser classification
- Safe under all conditions of normal use
- Free space coupling maximizes laser intensity at sample
- Software integration provides seamless Rheo-Raman experiments
- Synchronized data collection between TRIOS and Thermo Scientific™ OMNIC™ software
- Rheo-Raman data analysis performed in OMNIC software
- Temperature control up to 100 °C using Upper Heated Plate (UHP)
- Optical table provides excellent stability, alignment, and vibration free measurements
- Micrometer driven access to any radial positions
- Fine axial adjustment for focusing inside the sample
- Quartz plates minimize fluorescence artefacts

The Rheo-Raman results from the temperature ramp test are shown in the plot to the right – the data display excellent agreement between bulk rheology and chemical structural changes. As the lotion is heated, the storage and loss moduli drop significantly. This is accompanied by reduction in the Symmetric/Antisymmetric peak ratio and a concurrent increase in the number of Gauche conformers.

Together, the changes in the Raman spectra reveal an increase in chain mobility and a transition to amorphous content, consistent with the melting of the oil phase in the lotion and the changes in sample rheology. This example demonstrates the effectivity of Rheo-Raman analysis to specifically correlate chemical structural changes with rheology, enabling formulators to prescriptively tune the product performance through its chemical composition.

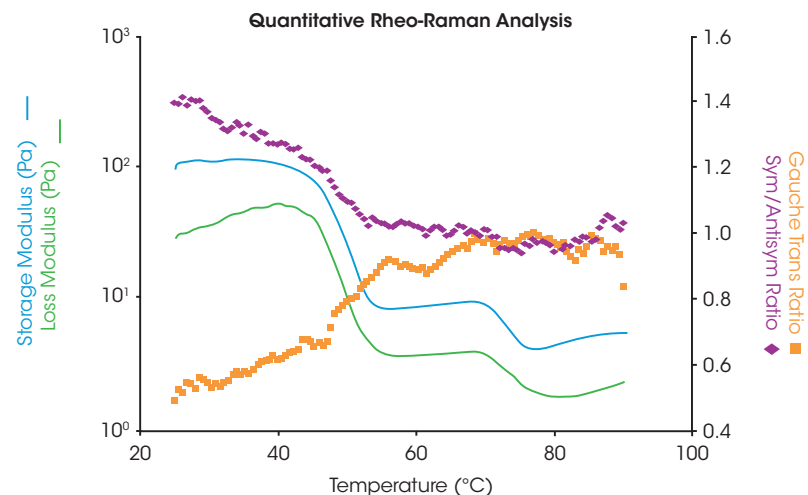
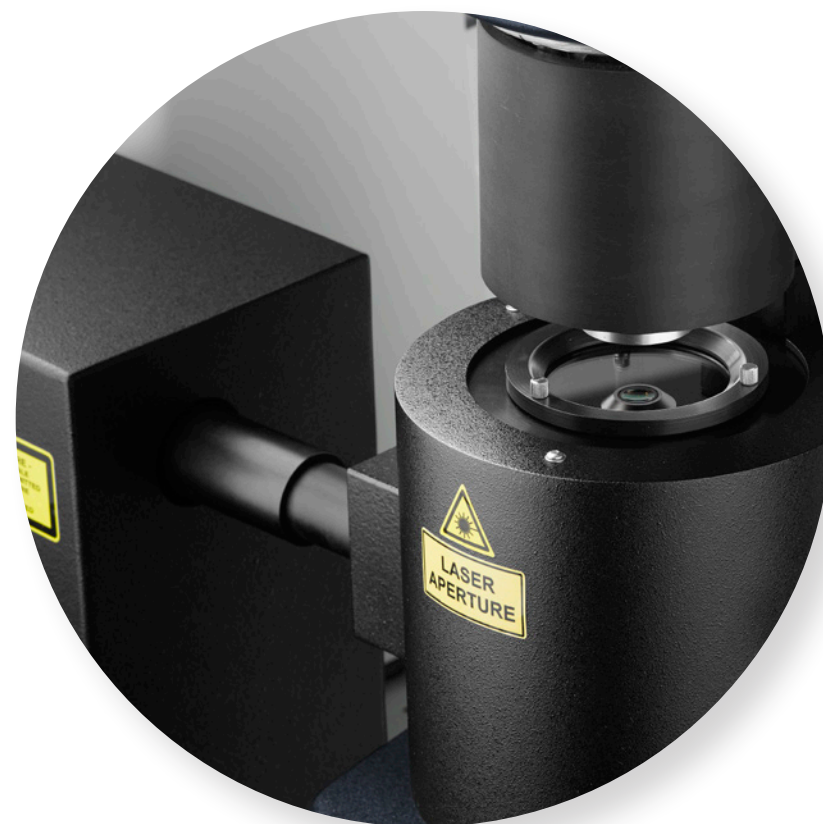



AMERICAS

- New Castle, DE USA
- Lindon, UT USA
- Eden Prairie, MN USA
- Chicago, IL USA
- Costa Mesa, CA USA
- Montreal, Canada
- Toronto, Canada
- Mexico City, Mexico
- São Paulo, Brazil

EUROPE

- Hüllhorst, Germany
- Eschborn, Germany
- Wetzlar, Germany
- Elstree, United Kingdom
- Brussels, Belgium
- Etten-Leur, Netherlands
- Paris, France
- Barcelona, Spain
- Milano, Italy
- Warsaw, Poland
- Prague, Czech Republic
- Solna, Sweden
- Copenhagen, Denmark

ASIA & AUSTRALIA

- Shanghai, China
- Beijing, China
- Tokyo, Japan
- Seoul, South Korea
- Taipei, Taiwan
- Guangzhou, China
- Petaling Jaya, Malaysia
- Singapore
- Bangalore, India
- Sydney, Australia



TA Instruments and Waters are trademarks of Waters Corporation.
All other trademarks are the property of their respective owners.

©2024 Waters Corporation. All rights reserved.
July 2024 RH00002EN Rev. A

TA Instruments

159 Lukens Drive
New Castle, DE 19720 U.S.A.
T: 1 302 427 4000
F: 1 302 427 4041
www.tainstruments.com

Waters Corporation

34 Maple Street
Milford, MA 01757 U.S.A.
T: 1 508 478 2000
F: 1 508 872 1990
www.waters.com